



**CS425 – Fall 2013**  
**Boris Glavic**  
**Chapter 7: Entity-Relationship Model**

**Partially taken from**  
**Klaus R. Dittrich**

**modified from:**

**Database System Concepts, 6<sup>th</sup> Ed.**

©Silberschatz, Korth and Sudarshan  
See [www.db-book.com](http://www.db-book.com) for conditions on re-use



# Chapter 7: Entity-Relationship Model

- Design Process
- Modeling
- Constraints
- E-R Diagram
- Design Issues
- Weak Entity Sets
- Extended E-R Features
- Design of the Bank Database
- Reduction to Relation Schemas
- Database Design
- UML



# Database Design

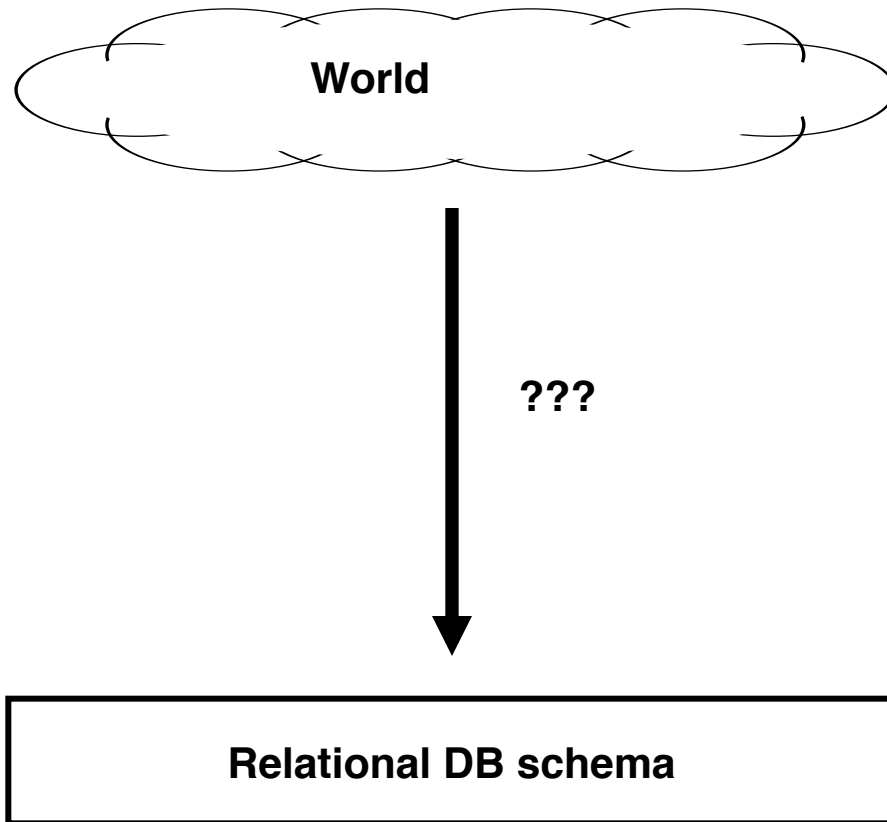



# Database Design

- First: need to develop a “mind”-model based on a requirement analysis

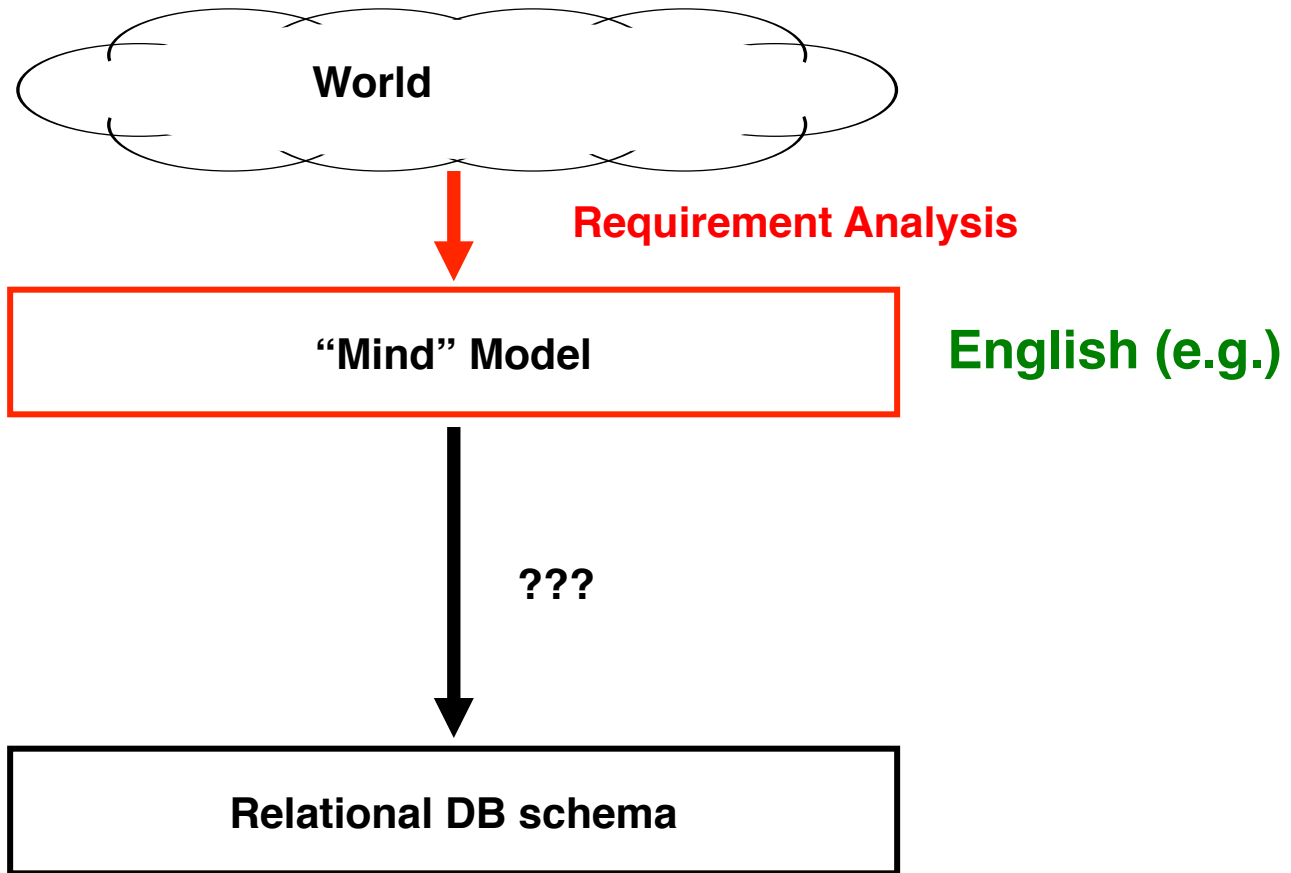



# Requirement Analysis Example

## Zoo

- The zoo stores information about animals, cages, and zoo keepers.
- Animals are of a certain species and have a name. For each animal we want to record its weight and age.
- Each cage is located in a section of the zoo. Cages can house animals, but there may be cages that are currently empty. Cages have a size in square meter.
- Zoo keepers are identified by their social security number. We store a first name, last name, and for each zoo keeper. Zoo keepers are assigned to cages they have to take care of (clean, ...). Each cage that is not empty has a zoo keeper assigned to it. A zoo keeper can take care of several cages. Each zoo keeper takes care of at least one cage.



# Requirement Analysis Example

## Music Collection

- Let's do it!



# Database Design

- Second: Formalize this model by developing a conceptual model

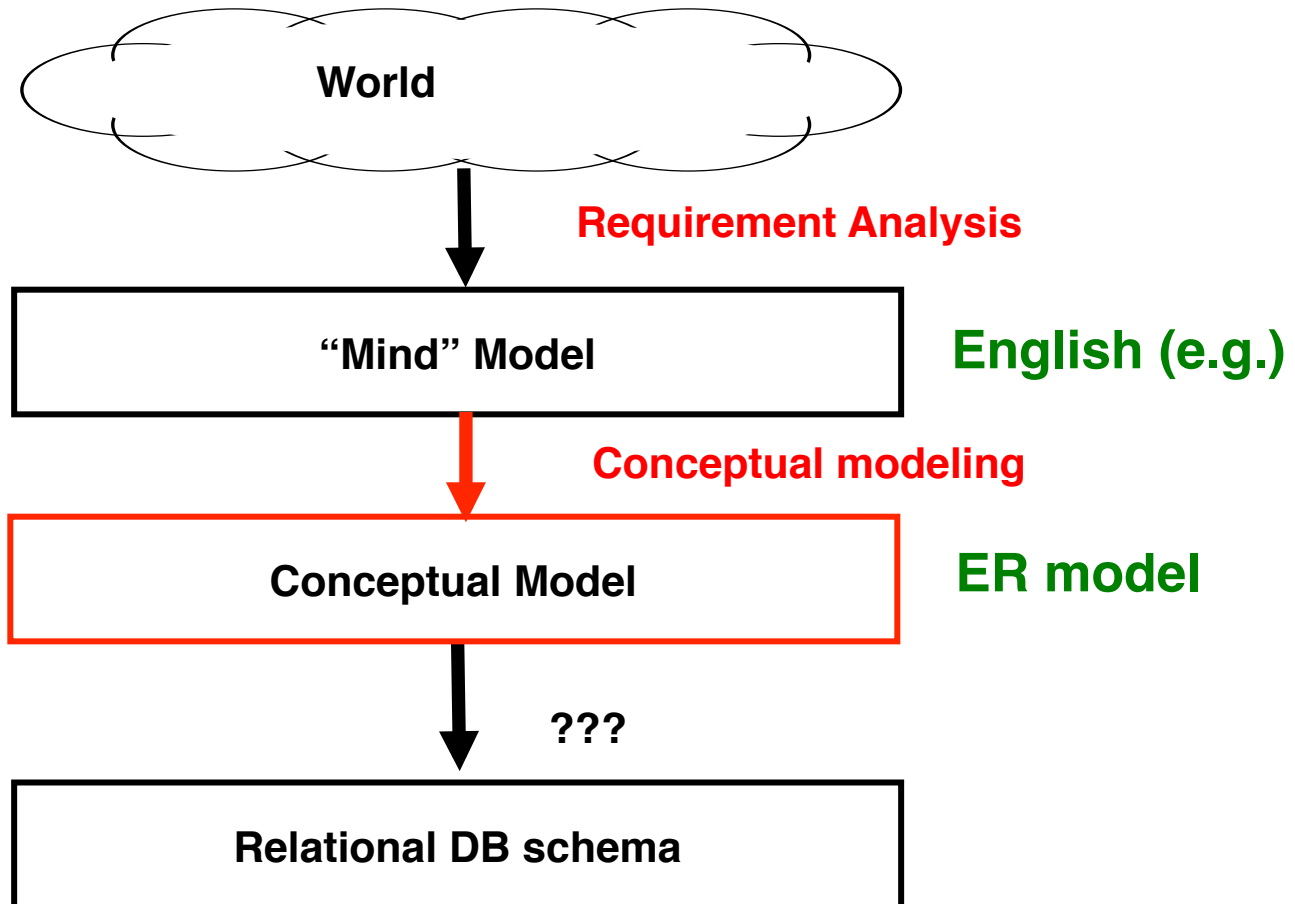



# Database Design

- Second: Formalize this model by developing a conceptual model

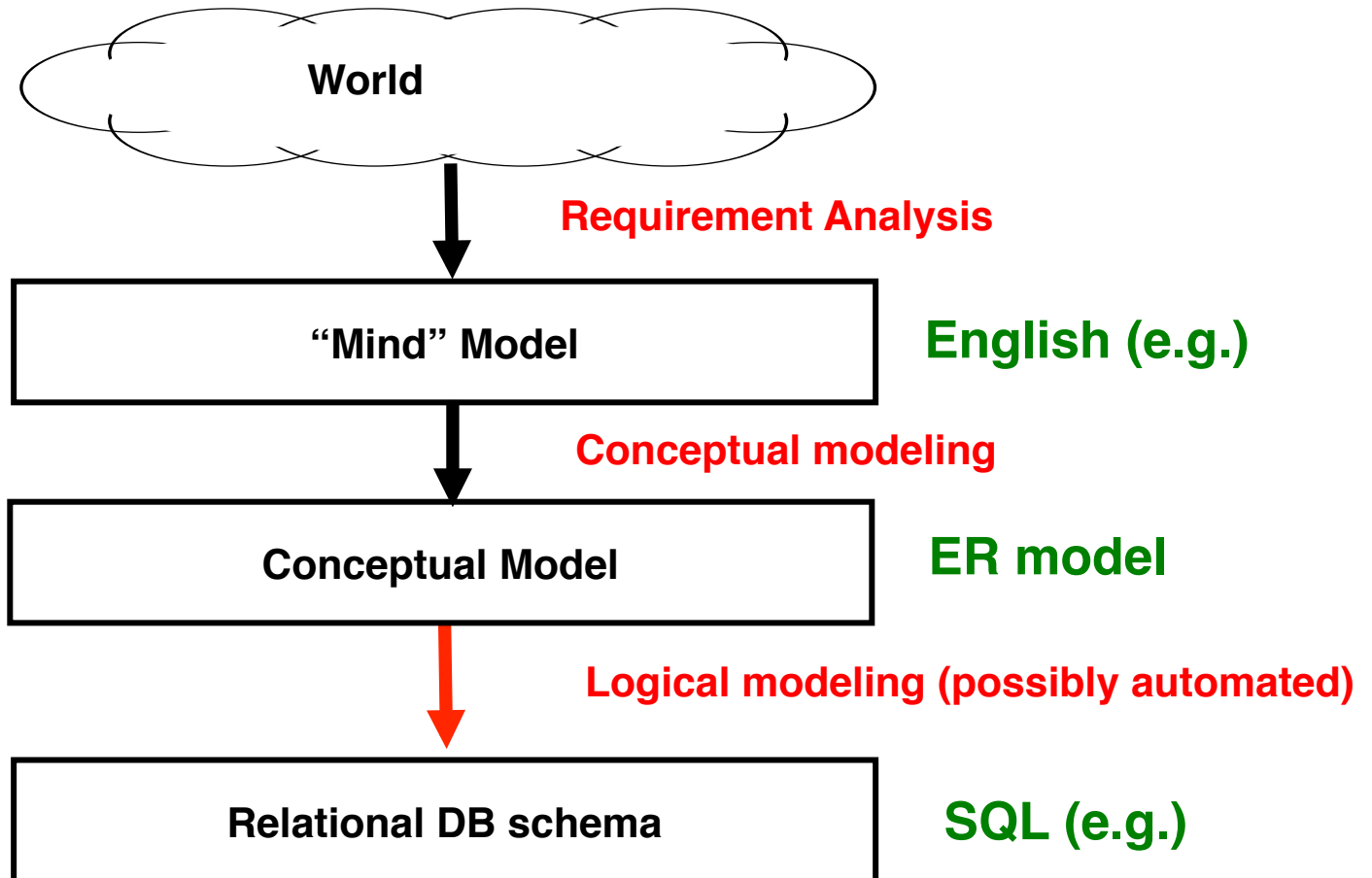





# Modeling – ER model

- A *database* can be modeled as:
  - a collection of entities,
  - relationship among entities.
- An **entity** is an object that exists and is distinguishable from other objects.
  - Example: specific person, company, event, plant
- Entities have **attributes**
  - Example: people have *names* and *addresses*
- An **entity set** is a set of entities of the same type that share the same properties.
  - Example: set of all persons, companies, trees, holidays



# Entity Sets *instructor* and *student*

instructor\_ID instructor\_name

76766	Crick
45565	Katz
10101	Srinivasan
98345	Kim
76543	Singh
22222	Einstein

*instructor*

student-ID student\_name

98988	Tanaka
12345	Shankar
00128	Zhang
76543	Brown
76653	Aoi
23121	Chavez
44553	Peltier

*student*



# Relationship Sets

- A **relationship** is an association among several entities

Example:

44553 (Peltier)	<u>advisor</u>	22222 (Einstein)
<i>student</i> entity	relationship set	<i>instructor</i> entity

- A **relationship set** is a mathematical relation among  $n \geq 2$  entities, each taken from entity sets

$$\{(e_1, e_2, \dots, e_n) \mid e_1 \in E_1, e_2 \in E_2, \dots, e_n \in E_n\}$$

where  $(e_1, e_2, \dots, e_n)$  is a relationship

- Example:

$$(44553, 22222) \in \text{advisor}$$



# Relationship Set *advisor*

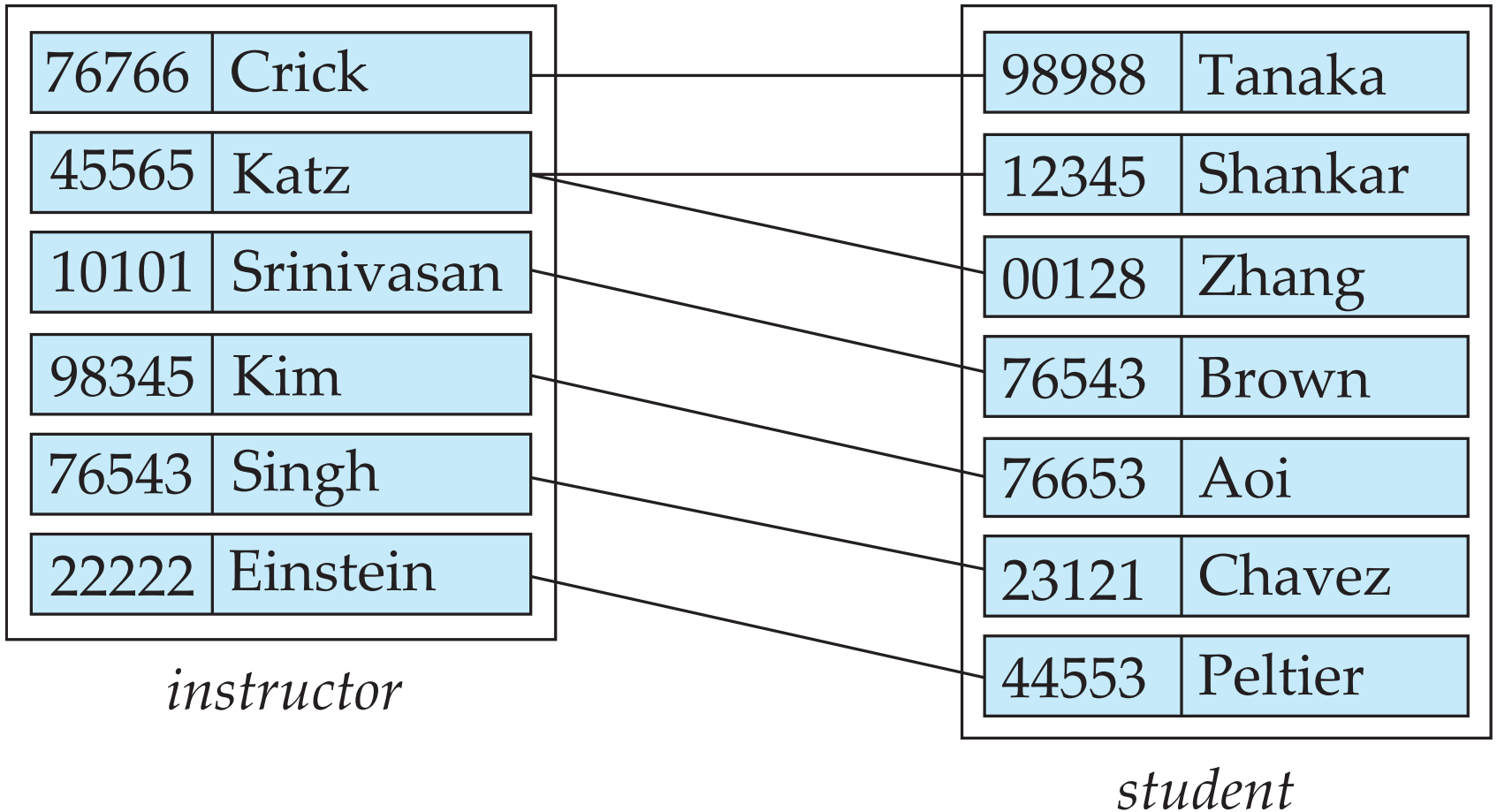



# Relationship Sets (Cont.)

- An **attribute** can also be property of a relationship set.
- For instance, the *advisor* relationship set between entity sets *instructor* and *student* may have the attribute *date* which tracks when the student started being associated with the advisor

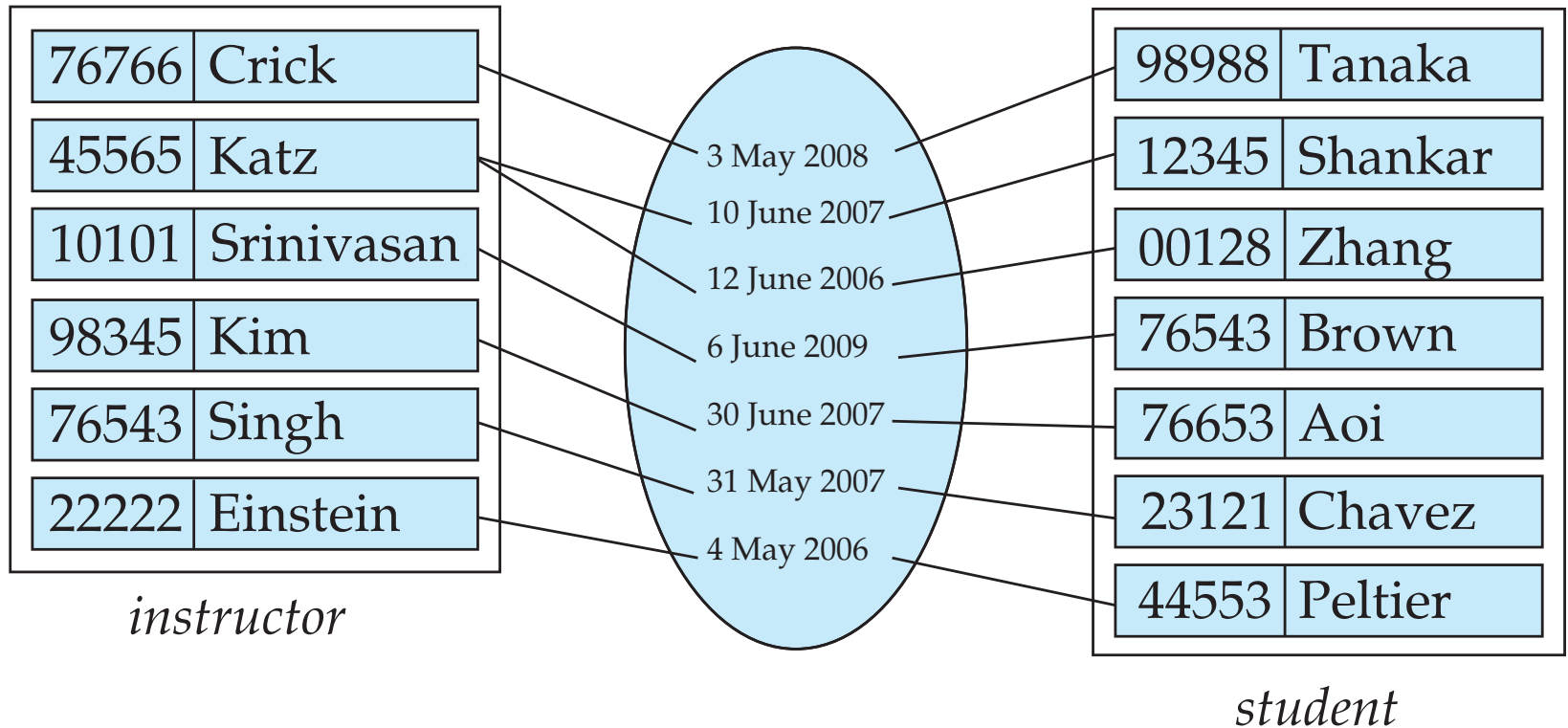



# Degree of a Relationship Set

## ■ **binary relationship**

- involve two entity sets (or degree two).
- Relationships between more than two entity sets are rare. Most relationships are binary. (More on this later.)
  - ▶ Example: *students* work on research *projects* under the guidance of an *instructor*.
  - ▶ relationship *proj\_guide* is a ternary relationship between *instructor*, *student*, and *project*



# Attributes

- An entity is represented by a set of attributes, that are descriptive properties possessed by all members of an entity set.

- Example:

*instructor = (ID, name, street, city, salary )*

*course = (course\_id, title, credits)*

- **Domain** – the set of permitted values for each attribute

- Attribute types:

- **Simple** and **composite** attributes.

- **Single-valued** and **multivalued** attributes

- ▶ Example: multivalued attribute: *phone\_numbers*

- **Derived** attributes

- ▶ Can be computed from other attributes

- ▶ Example: age, given date\_of\_birth



# Composite Attributes

composite  
attributes

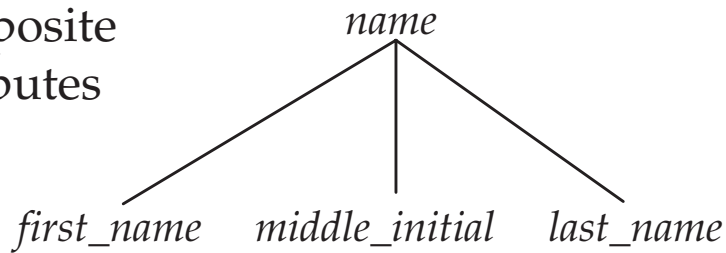

component  
attributes

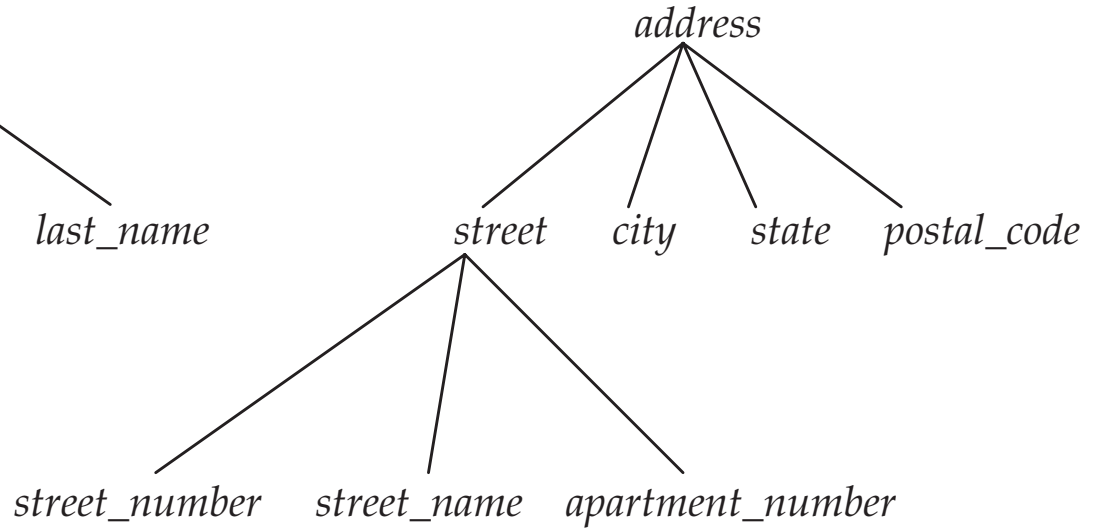





# Mapping Cardinality Constraints

- Express the number of entities to which another entity can be associated via a relationship set.
- For a binary relationship set the mapping cardinality must be one of the following types:
  - One to one (**1-1**)
  - One to many (**1-N**)
  - Many to one (**N-1**)
  - Many to many (**N-M**)



# Mapping Cardinalities

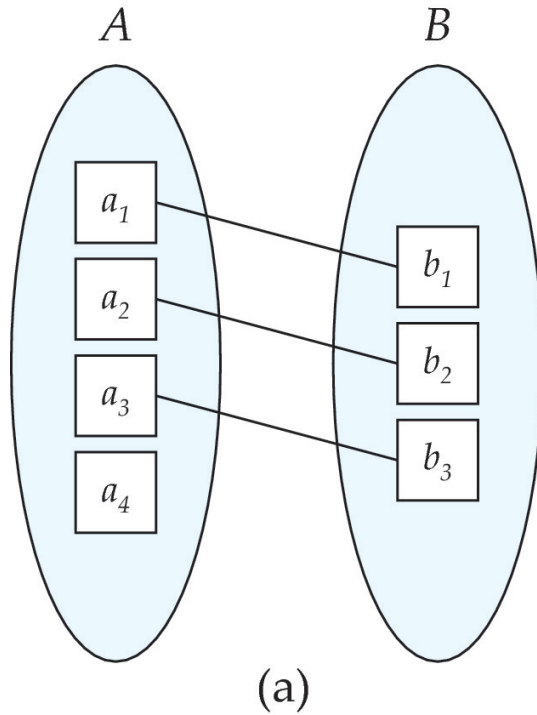

One to one

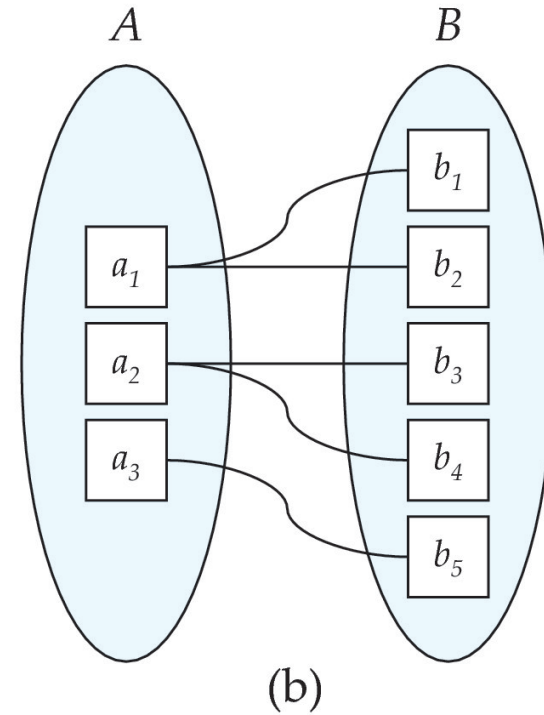

One to many

Note: Some elements in  $A$  and  $B$  may not be mapped to any elements in the other set



# Mapping Cardinalities Example

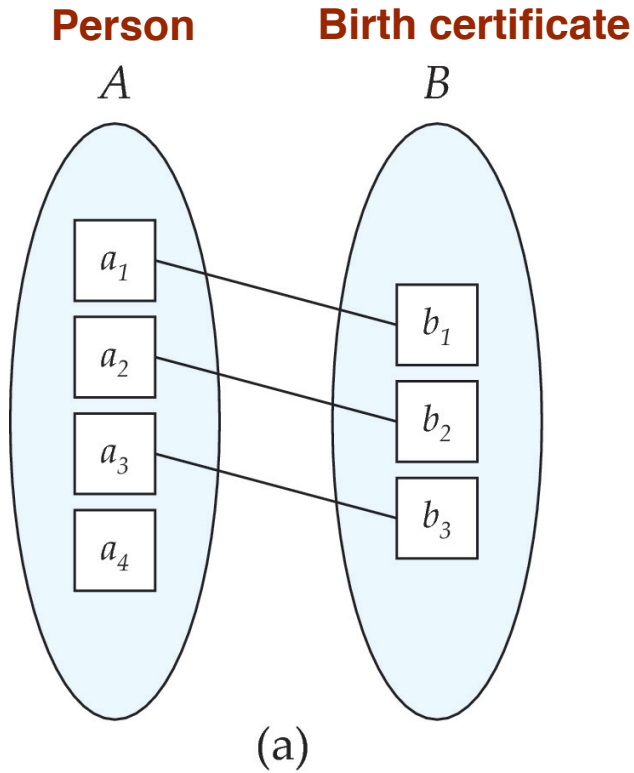

One to one

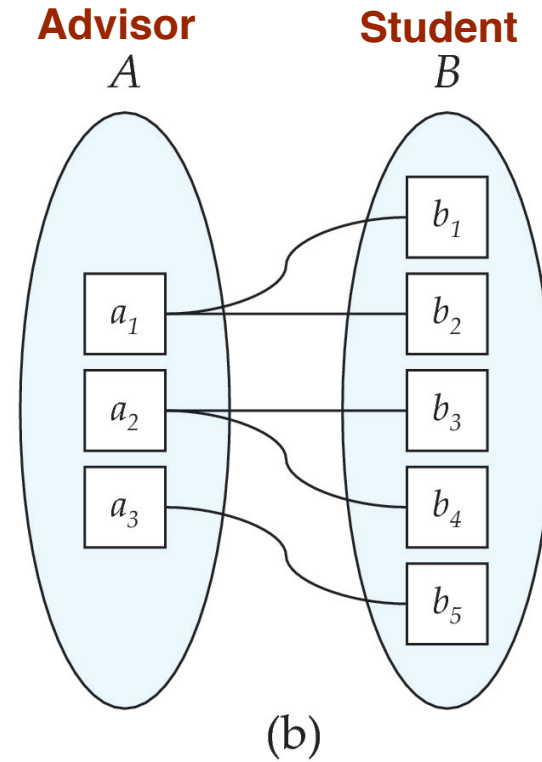

One to many

Note: Some elements in *A* and *B* may not be mapped to any elements in the other set



# Mapping Cardinalities

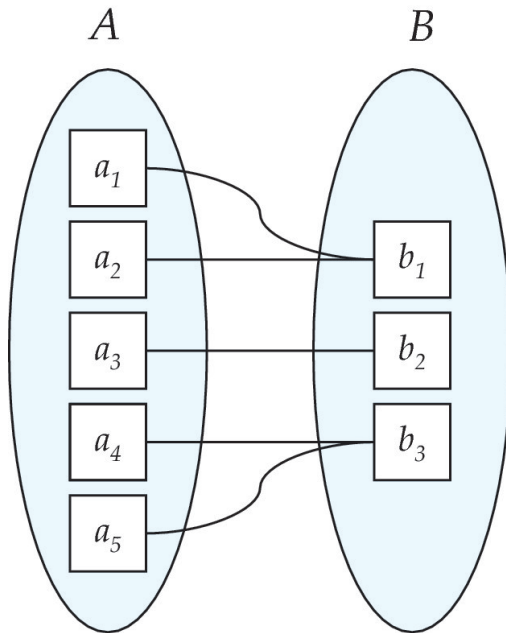

(a)

Many to one

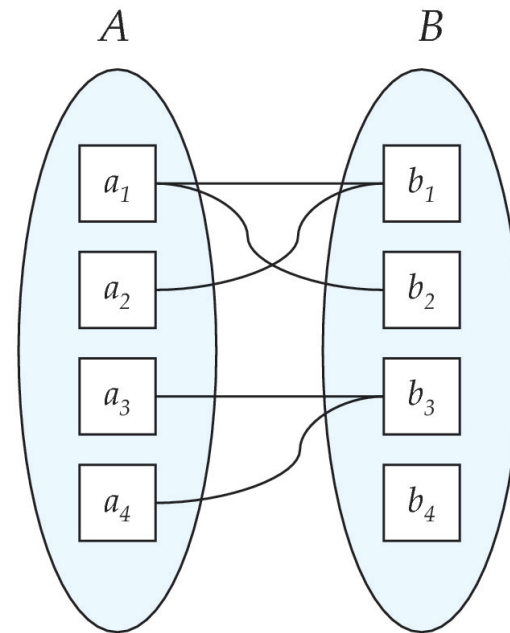

(b)

Many to many

Note: Some elements in A and B may not be mapped to any elements in the other set



# Mapping Cardinalities Example

**Employee**      **Department**

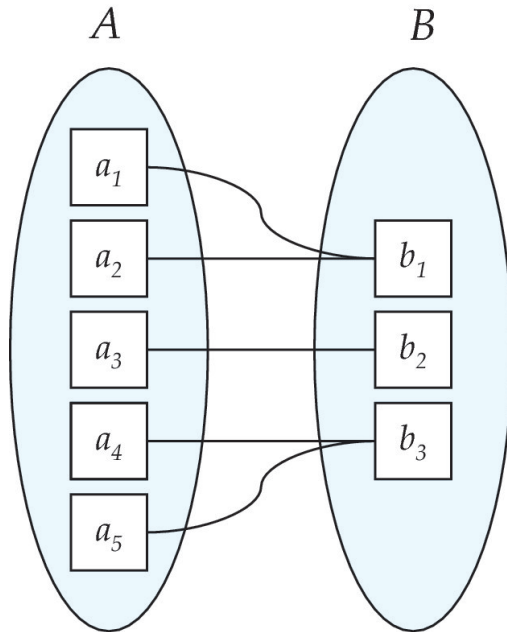

(a)

Many to one

**Student**      **Course**

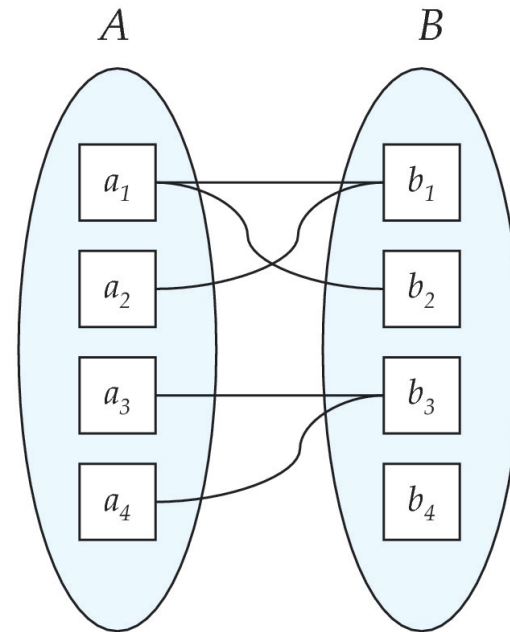

(b)

Many to many

Note: Some elements in A and B may not be mapped to any elements in the other set



# Mapping Cardinality Constraints Cont.

- What if we allow some elements to not be mapped to another element?
  - E.g., 0:1 – 1
- For a binary relationship set the mapping cardinality must be one of the following types:

- **1-1**

- 1-1
- 0:1-1
- 1-0:1
- 0:1-0:1

- **1-N**

- 0:1-N
- 0:1-0:N
- 1-N
- 1-0:N

- **N-1**

- N-1
- N-0:1
- 0:N-1
- 0:N-0:1

- **N-M**

- N-M
- N-0:M
- 0:N-M
- 0:N-0:M



# Mapping Cardinality Constraints Cont.

- Typical Notation
  - (0:1) – (1:N)



# Keys

- A **super key** of an entity set is a set of one or more attributes whose values uniquely determine each entity.
- A **candidate key** of an entity set is a minimal super key
  - *ID* is candidate key of *instructor*
  - *course\_id* is candidate key of *course*
- Although several candidate keys may exist, one of the candidate keys is selected to be the **primary key**.
  
- **Note: Basically the same as for relational model**





# Keys for Relationship Sets

- The combination of primary keys of the participating entity sets forms a super key of a relationship set.
  - $(s\_id, i\_id)$  is the super key of *advisor*
  - **NOTE: this means *a pair of entities can have at most one relationship in a particular relationship set.***
    - ▶ Example: if we wish to track multiple meeting dates between a student and her advisor, we cannot assume a relationship for each meeting. We can use a multivalued attribute though or model meeting as a separate entity
- Must consider the mapping cardinality of the relationship set when deciding what are the candidate keys
- Need to consider semantics of relationship set in selecting the *primary key* in case of more than one candidate key



# Keys for Relationship Sets Cont.

- Must consider the mapping cardinality of the relationship set when deciding what are the candidate keys
  - 1-1: both primary keys are candidate keys
    - ▶ Example: **hasBc**: (Person-Birthcertificate)
  - N-1: the N side is the candidate key
    - ▶ Example: **worksFor**: (Instructor-Department)
  - N-M: the combination of both primary keys
    - ▶ Example: **takes**: (Student-Course)



# Redundant Attributes

- Suppose we have entity sets
  - *instructor*, with attributes including *dept\_name*
  - *department*and a relationship
  - *inst\_dept* relating *instructor* and *department*
- Attribute *dept\_name* in entity *instructor* is redundant since there is an explicit relationship *inst\_dept* which relates instructors to departments
  - The attribute replicates information present in the relationship, and should be removed from *instructor*
  - BUT: when converting back to tables, in some cases the attribute gets reintroduced, as we will see.



# E-R Diagrams

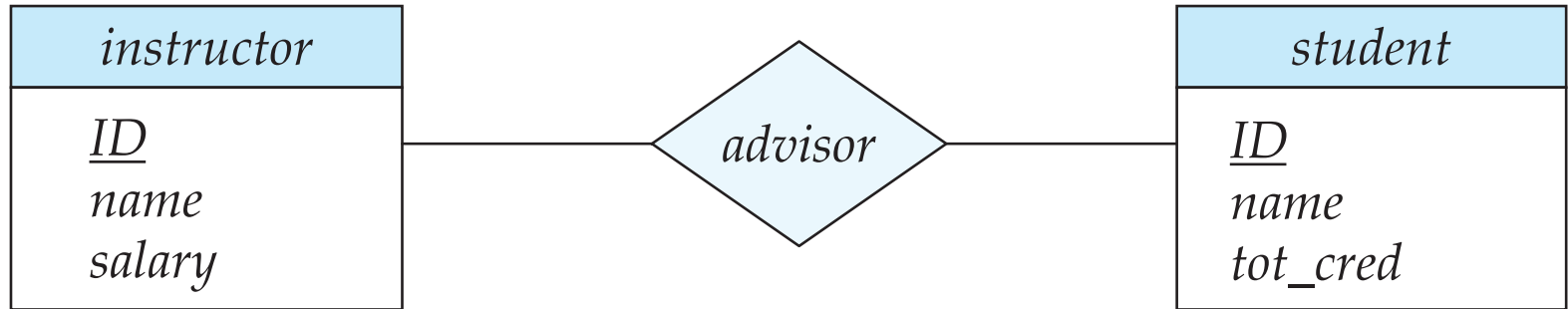

- Rectangles represent entity sets.
- Diamonds represent relationship sets.
- Attributes listed inside entity rectangle
- Underline indicates primary key attributes



# Entity With Composite, Multivalued, and Derived Attributes

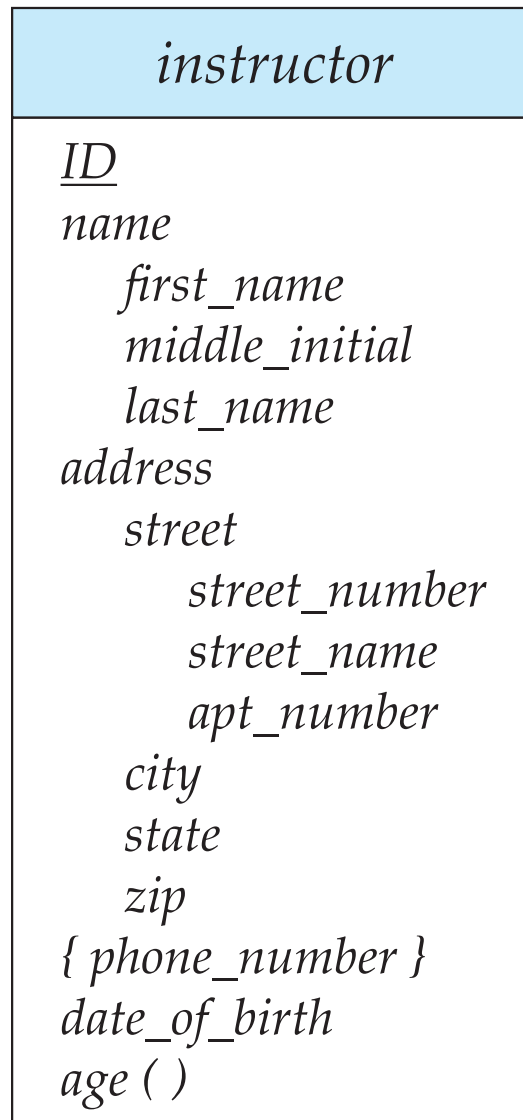



# Entity With Composite, Multivalued, and Derived Attributes

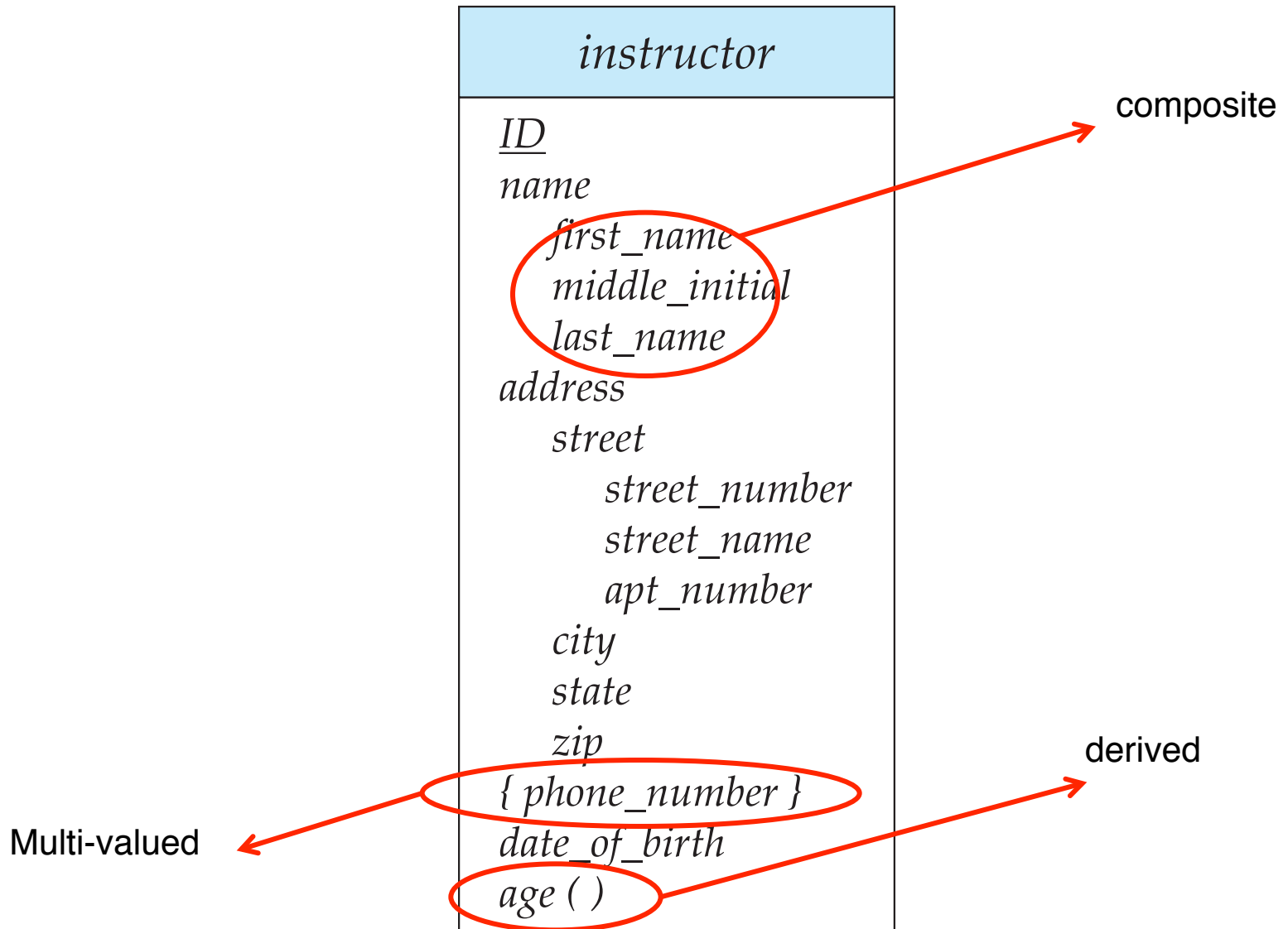



# Relationship Sets with Attributes

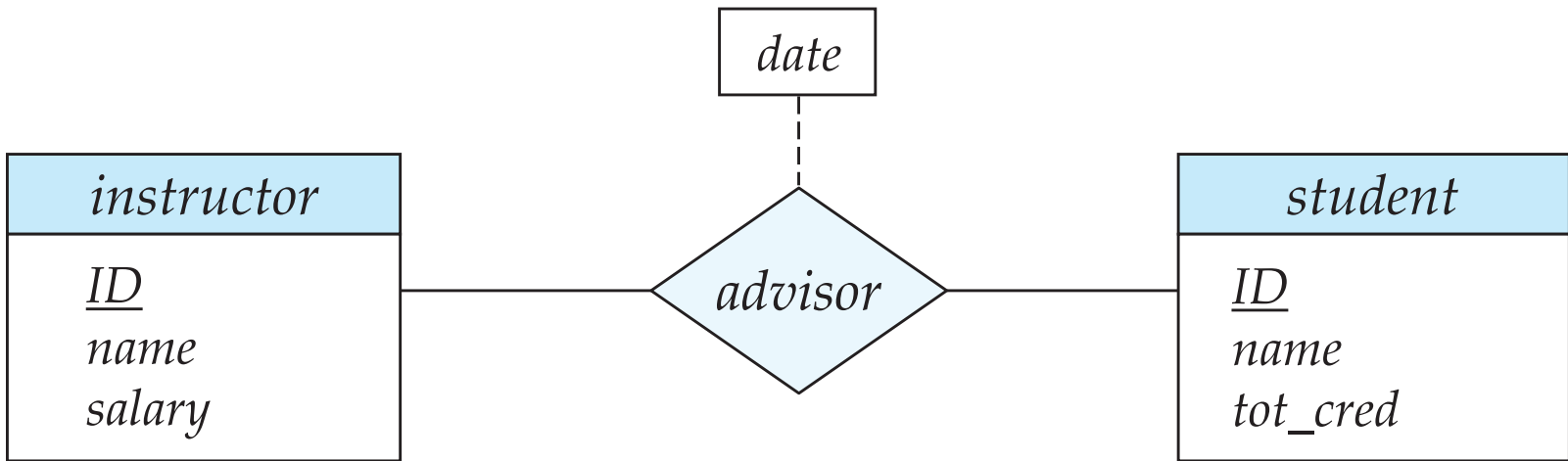



# Roles

- Entity sets of a relationship need not be distinct
  - Each occurrence of an entity set plays a “role” in the relationship
- The labels “*course\_id*” and “*prereq\_id*” are called **roles**.

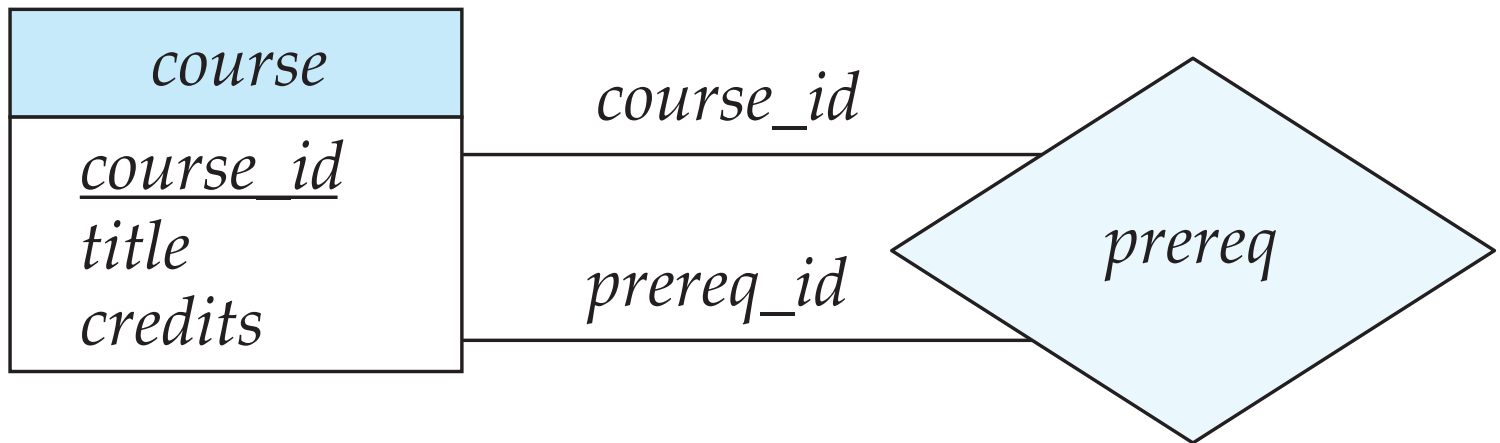





# Cardinality Constraints

- We express cardinality constraints by drawing either a directed line ( $\rightarrow$ ), signifying “one,” or an undirected line ( $-$ ), signifying “many,” between the relationship set and the entity set.
- One-to-one relationship:
  - A student is associated with at most one *instructor* via the relationship *advisor*
  - A *student* is associated with at most one *department* via *stud\_dept*



# One-to-One Relationship

- one-to-one relationship between an *instructor* and a *student*
  - an instructor is associated with at most one student via *advisor*
  - and a student is associated with at most one instructor via *advisor*

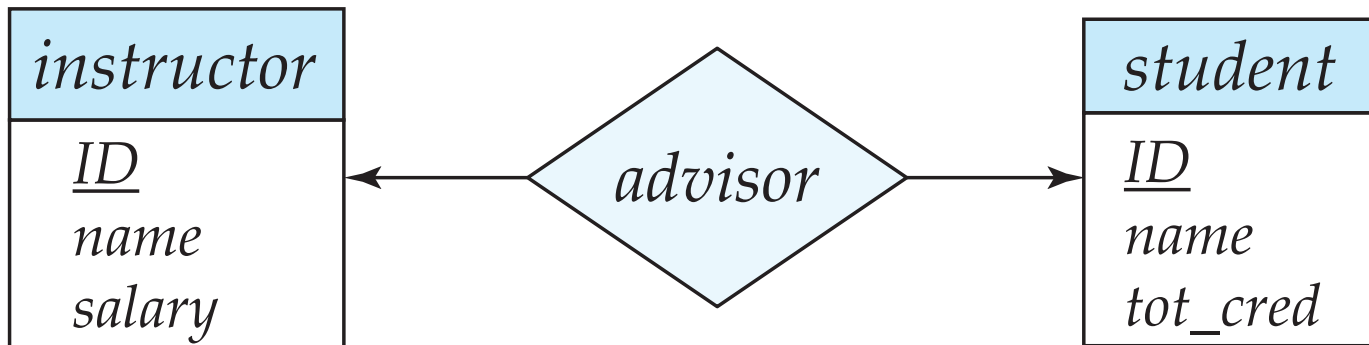



# One-to-Many Relationship

- one-to-many relationship between an *instructor* and a *student*
  - an instructor is associated with several (including 0) students via *advisor*
  - a student is associated with at most one instructor via *advisor*,

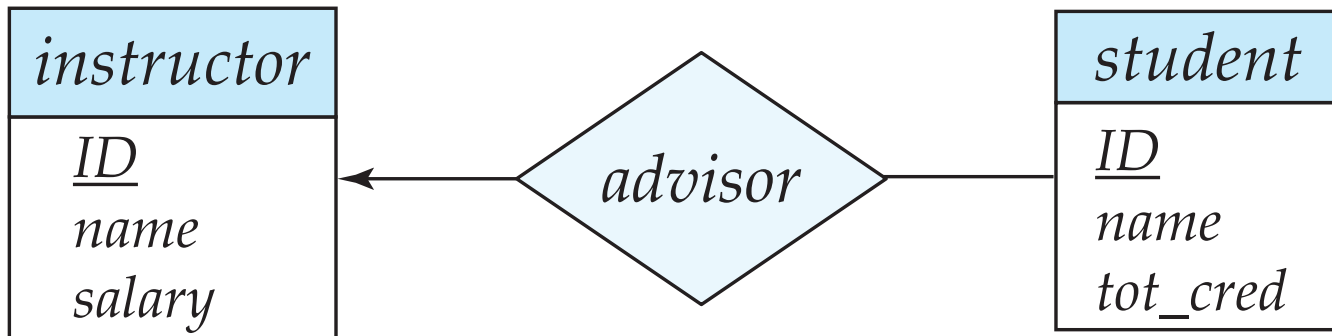



# Many-to-One Relationships

- In a many-to-one relationship between an *instructor* and a *student*,
  - an instructor is associated with at most one student via *advisor*,
  - and a student is associated with several (including 0) instructors via *advisor*

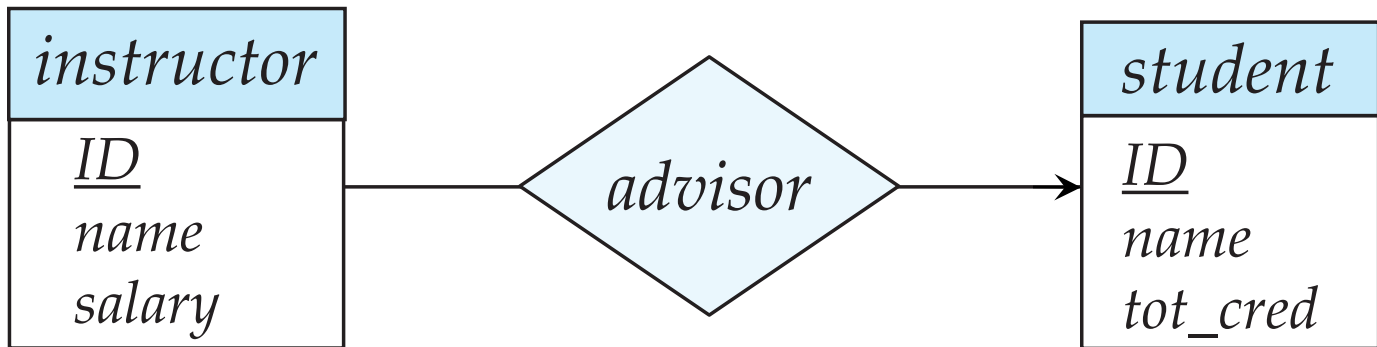



# Many-to-Many Relationship

- An instructor is associated with several (possibly 0) students via *advisor*
- A student is associated with several (possibly 0) instructors via *advisor*

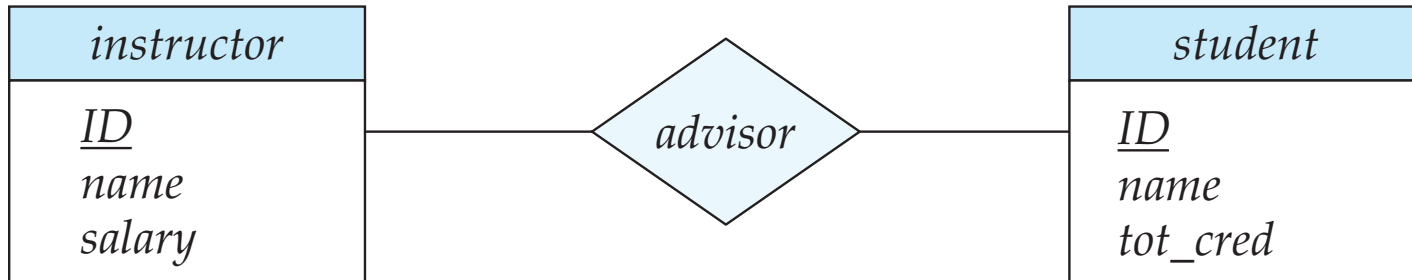



# Participation of an Entity Set in a Relationship Set

- Total participation (indicated by double line): every entity in the entity set participates in at least one relationship in the relationship set
  - E.g., participation of *section* in *sec\_course* is total
    - ▶ every *section* must have an associated course
- Partial participation: some entities may not participate in any relationship in the relationship set
  - Example: participation of *instructor* in *advisor* is partial

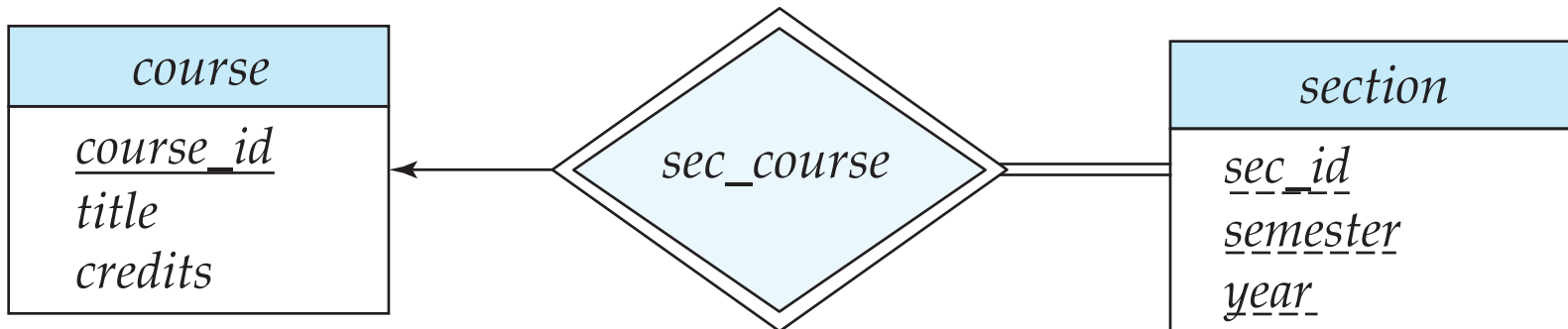



# Alternative Notation for Cardinality Limits

- Cardinality limits can also express participation constraints

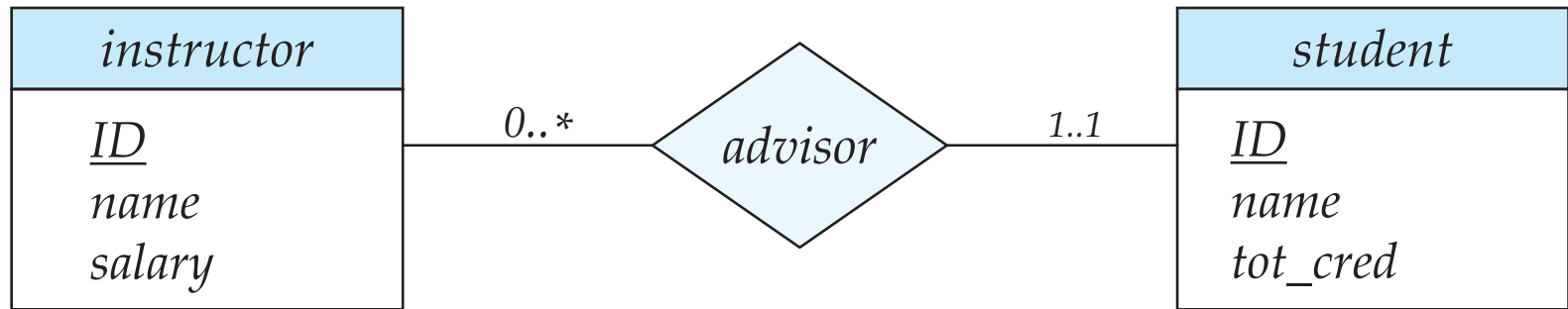



# Alternative Notation for Cardinality Limits

## ■ Alternative Notation

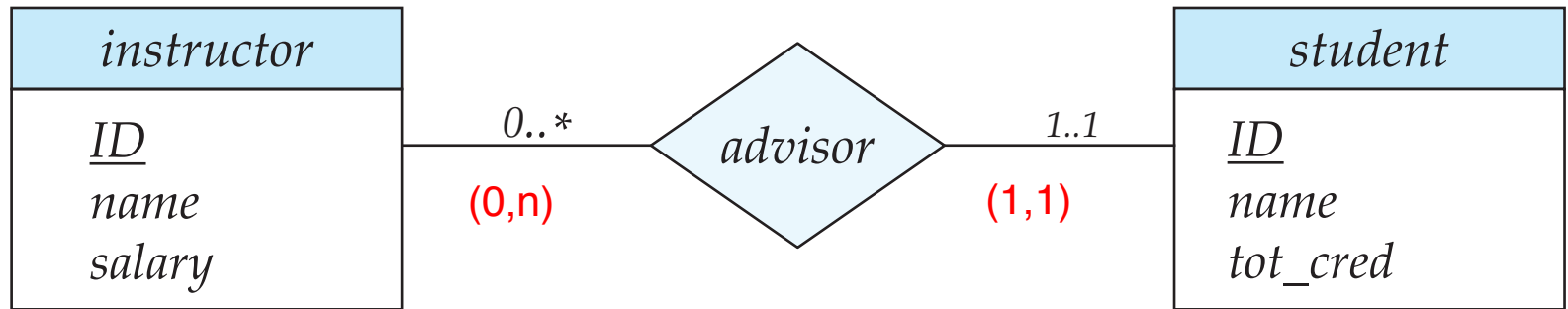





# E-R Diagram with a Ternary Relationship

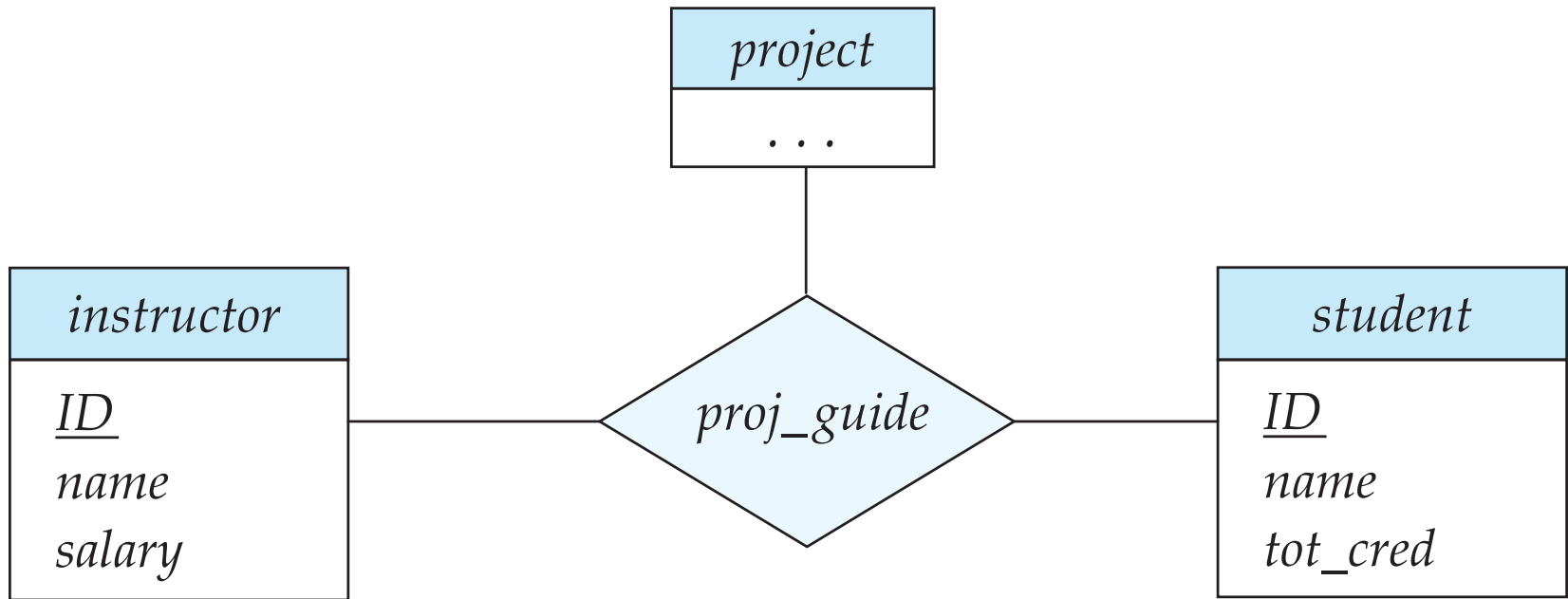



# Cardinality Constraints on Ternary Relationship

- We allow at most one arrow out of a ternary (or greater degree) relationship to indicate a cardinality constraint
- E.g., an arrow from *proj\_guide* to *instructor* indicates each student has at most one guide for a project
- If there is more than one arrow, there are two ways of defining the meaning.
  - E.g., a ternary relationship  $R$  between  $A$ ,  $B$  and  $C$  with arrows to  $B$  and  $C$  could mean
    1. each  $A$  entity is associated with a unique entity from  $B$  and  $C$  or
    2. each pair of entities from  $(A, B)$  is associated with a unique  $C$  entity, and each pair  $(A, C)$  is associated with a unique  $B$
  - Each alternative has been used in different formalisms
  - To avoid confusion we outlaw more than one arrow
- **Better to use cardinality constraints such as  $(0,n)$**



# Let's design an ER-model for parts of the university database

Partially taken from  
Klaus R. Dittrich

modified from:

**Database System Concepts, 6<sup>th</sup> Ed.**

©Silberschatz, Korth and Sudarshan  
See [www.db-book.com](http://www.db-book.com) for conditions on re-use



# Lets design an ER-model for parts of the university database

- 1) Identify Entities
- 2) Identify Relationship
- 3) Determine Attributes
- 4) Determine Cardinality  
Constraints

Partially taken from  
Klaus R. Dittrich

modified from:

Database System Concepts, 6<sup>th</sup> Ed.

©Silberschatz, Korth and Sudarshan  
See [www.db-book.com](http://www.db-book.com) for conditions on re-use



# Weak Entity Sets

- An entity set that does not have a primary key is referred to as a **weak entity set**.
- The existence of a weak entity set depends on the existence of a **identifying entity set**
  - It must relate to the identifying entity set via a total, one-to-many relationship set from the identifying to the weak entity set
  - **Identifying relationship** depicted using a double diamond
- The **discriminator** (*or partial key*) of a weak entity set is the set of attributes that distinguishes among all the entities of a weak entity set that are associated with the same entity of the identifying entity set
- The primary key of a weak entity set is formed by the primary key of the strong entity set on which the weak entity set is existence dependent, plus the weak entity set's discriminator.



# Weak Entity Sets (Cont.)

- We underline the discriminator of a weak entity set with a dashed line.
- We put the identifying relationship of a weak entity in a double diamond.
- Primary key for *section* – (*course\_id*, *sec\_id*, *semester*, *year*)

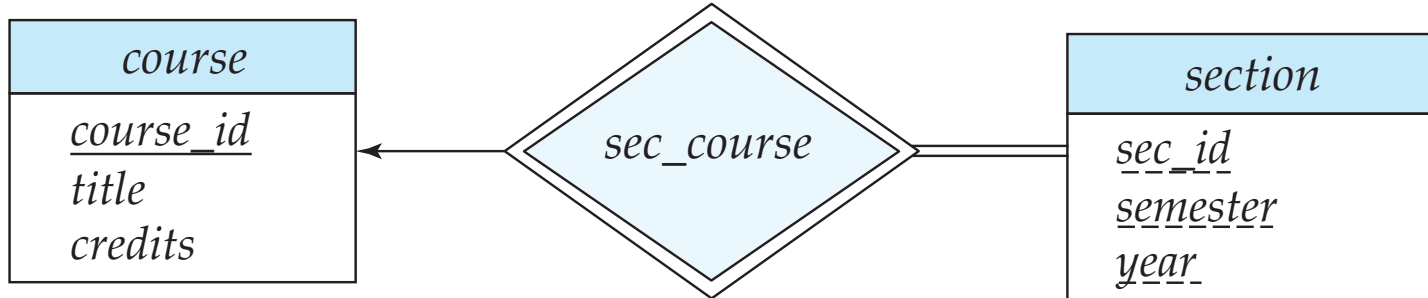



# Weak Entity Sets (Cont.)

- Note: the primary key of the strong entity set is not explicitly stored with the weak entity set, since it is implicit in the identifying relationship.
- If *course\_id* were explicitly stored, *section* could be made a strong entity, but then the relationship between *section* and *course* would be duplicated by an implicit relationship defined by the attribute *course\_id* common to *course* and *section*



# E-R Diagram for a University Enterprise

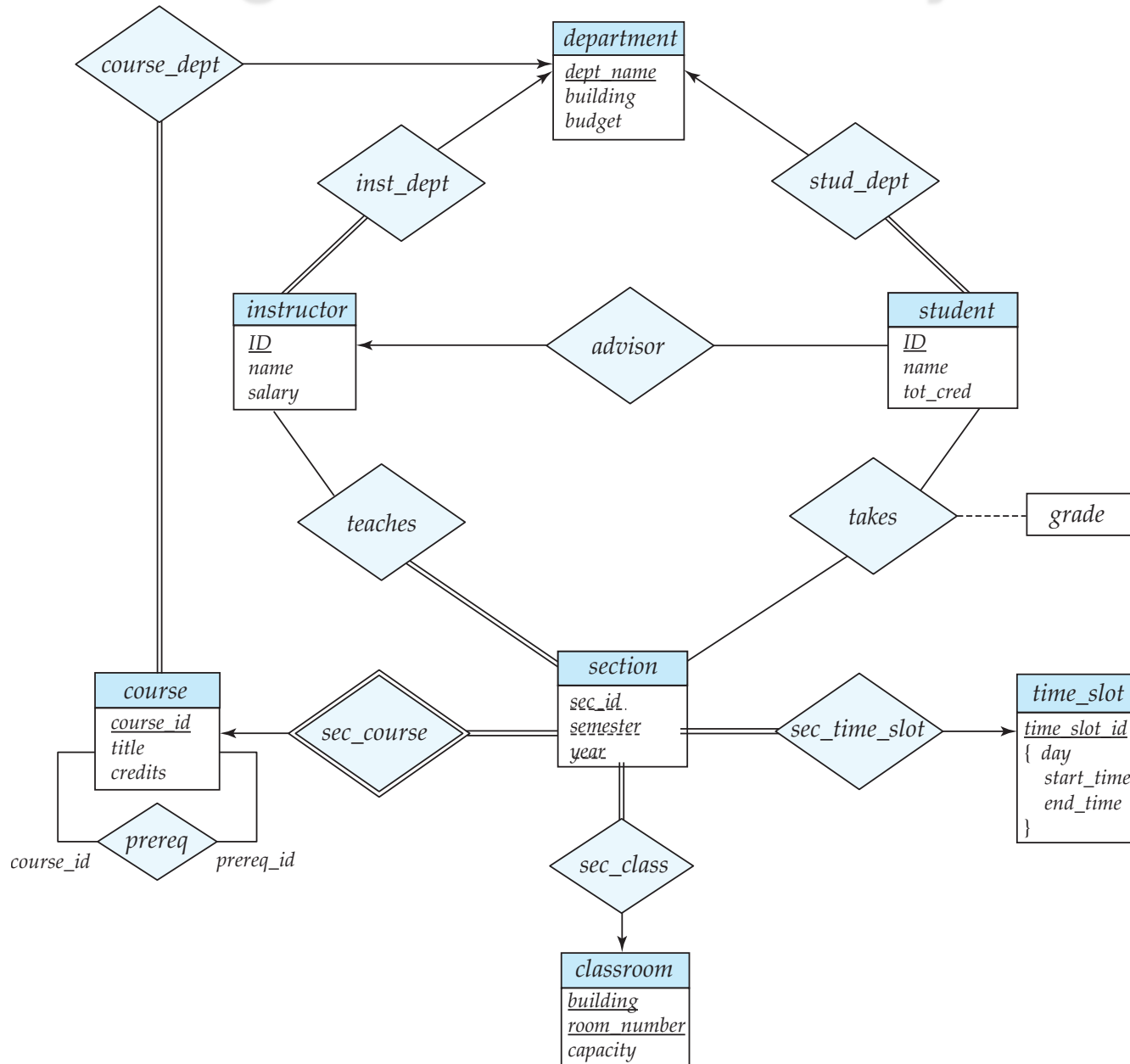





# Reduction to Relational Schemas



# Reduction to Relation Schemas

- Entity sets and relationship sets can be expressed uniformly as *relation schemas* that represent the contents of the database.
- A database which conforms to an E-R diagram can be represented by a collection of relation schemas.
- For each entity set and relationship set there is a unique relation schema that is assigned the name of the corresponding entity set or relationship set.



# Representing Entity Sets With Simple Attributes

- A strong entity set reduces to a schema with the same attributes  
*student*(ID, name, tot\_cred)
- A weak entity set becomes a table that includes a column for the primary key of the identifying strong entity set  
*section* ( course\_id, sec\_id, sem, year )

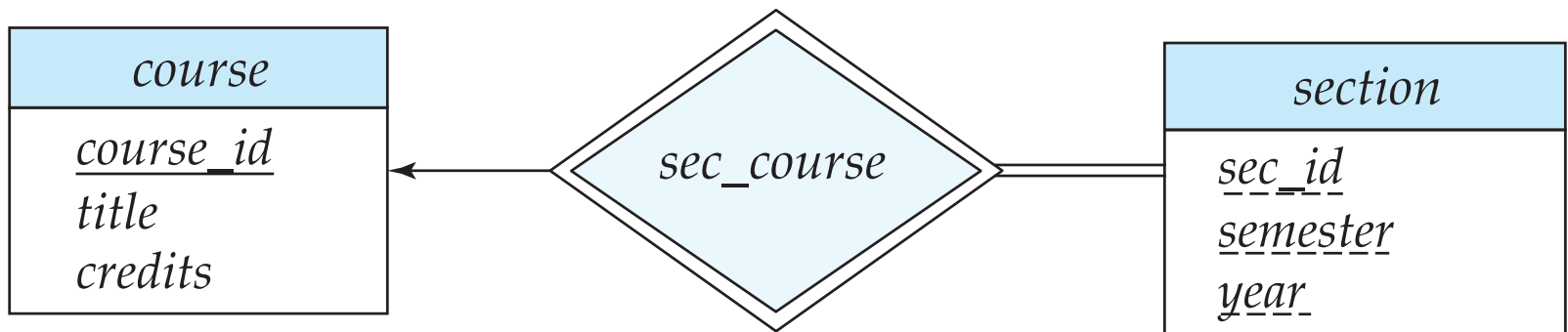



# Representing Relationship Sets

- A many-to-many relationship set is represented as a schema with attributes for the primary keys of the two participating entity sets, and any descriptive attributes of the relationship set.

- Example: schema for relationship set *advisor*

*advisor* = (*s\_id*, *i\_id*)

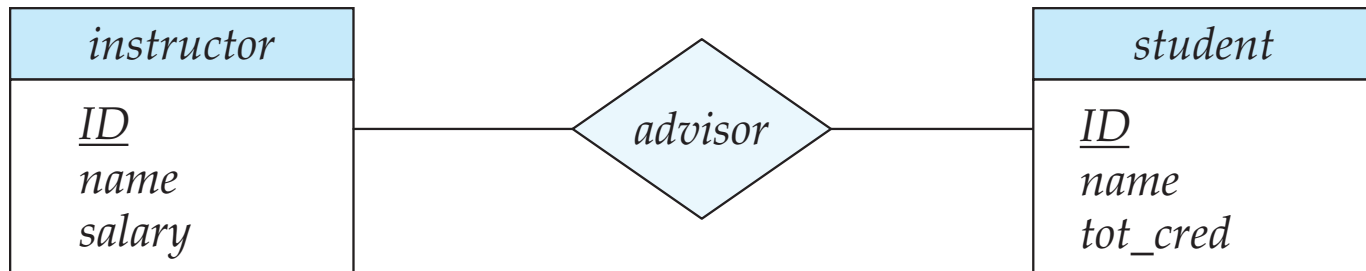



# Redundancy of Schemas

- Many-to-one and one-to-many relationship sets that are total on the many-side can be represented by adding an extra attribute to the “many” side, containing the primary key of the “one” side
- Example: Instead of creating a schema for relationship set *inst\_dept*, add an attribute *dept\_name* to the schema arising from entity set *instructor*

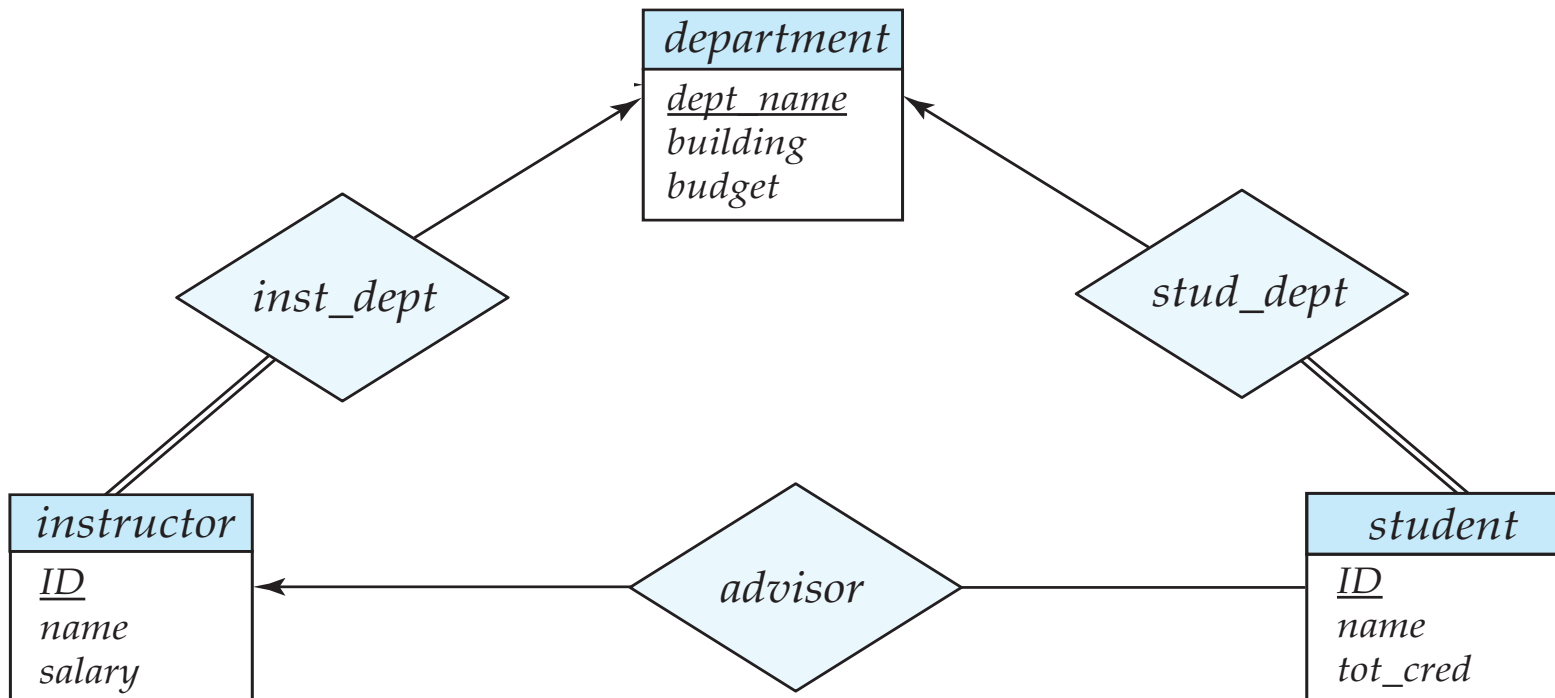



# Redundancy of Schemas (Cont.)

- For one-to-one relationship sets, either side can be chosen to act as the “many” side
  - That is, extra attribute can be added to either of the tables corresponding to the two entity sets
  - If the relationship is total in both sides, the relation schemas from the two sides can be merged into one schema
- If participation is *partial* on the “many” side, replacing a schema by an extra attribute in the schema corresponding to the “many” side could result in null values
- The schema corresponding to a relationship set linking a weak entity set to its identifying strong entity set is redundant.
  - Example: The *section* schema already contains the attributes that would appear in the *sec\_course* schema



# Composite and Multivalued Attributes

## *instructor*

ID  
*name*  
    *first\_name*  
    *middle\_initial*  
    *last\_name*  
*address*  
    *street*  
        *street\_number*  
        *street\_name*  
        *apt\_number*  
    *city*  
    *state*  
    *zip*  
    { *phone\_number* }  
    *date\_of\_birth*  
    *age* ( )

- Composite attributes are flattened out by creating a separate attribute for each component attribute
  - Example: given entity set *instructor* with composite attribute *name* with component attributes *first\_name* and *last\_name* the schema corresponding to the entity set has two attributes *name\_first\_name* and *name\_last\_name*
    - ▶ *Prefix omitted if there is no ambiguity*
- Ignoring multivalued attributes, extended instructor schema is
  - *instructor*(*ID*,  
    *first\_name*, *middle\_initial*, *last\_name*,  
    *street\_number*, *street\_name*,  
    *apt\_number*, *city*, *state*, *zip\_code*,  
    *date\_of\_birth*)



# Composite and Multivalued Attributes

- A multivalued attribute  $M$  of an entity  $E$  is represented by a separate schema  $EM$ 
  - Schema  $EM$  has attributes corresponding to the primary key of  $E$  and an attribute corresponding to multivalued attribute  $M$
  - Example: Multivalued attribute  $phone\_number$  of  $instructor$  is represented by a schema:  
 $inst\_phone = ( \underline{ID}, \underline{phone\_number} )$
  - Each value of the multivalued attribute maps to a separate tuple of the relation on schema  $EM$ 
    - ▶ For example, an  $instructor$  entity with primary key 22222 and phone numbers 456-7890 and 123-4567 maps to two tuples:  
(22222, 456-7890) and (22222, 123-4567)





# Multivalued Attributes (Cont.)

- Special case: entity *time\_slot* has only one attribute other than the primary-key attribute, and that attribute is multivalued
  - Optimization: Don't create the relation corresponding to the entity, just create the one corresponding to the multivalued attribute
  - *time\_slot*(*time\_slot\_id*, *day*, *start\_time*, *end\_time*)
  - Caveat: *time\_slot* attribute of *section* (from *sec\_time\_slot*) cannot be a foreign key due to this optimization

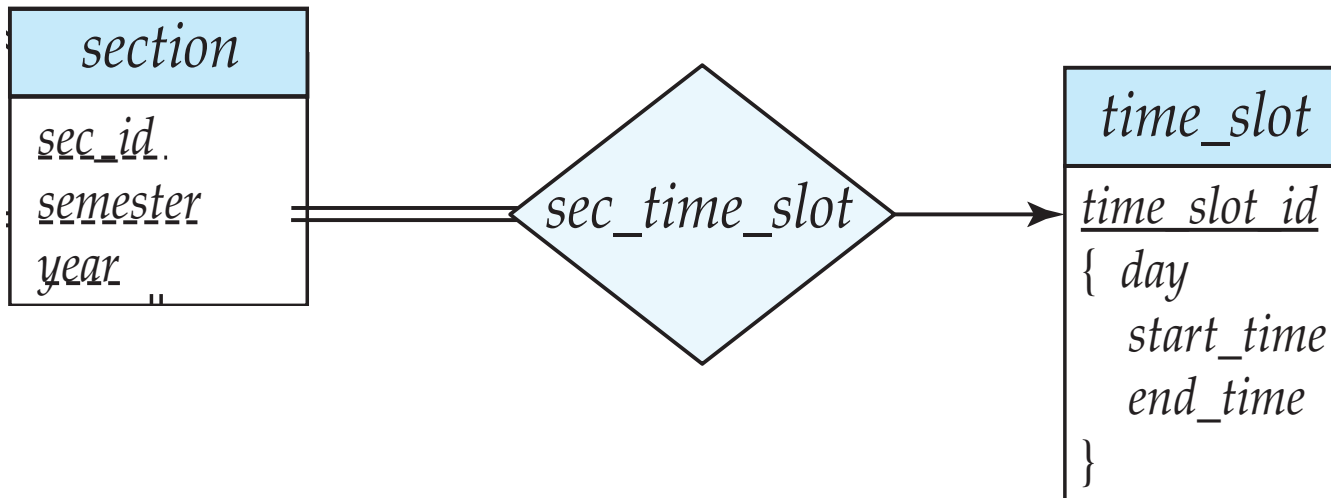



# Design Issues

## ■ Use of entity sets vs. attributes

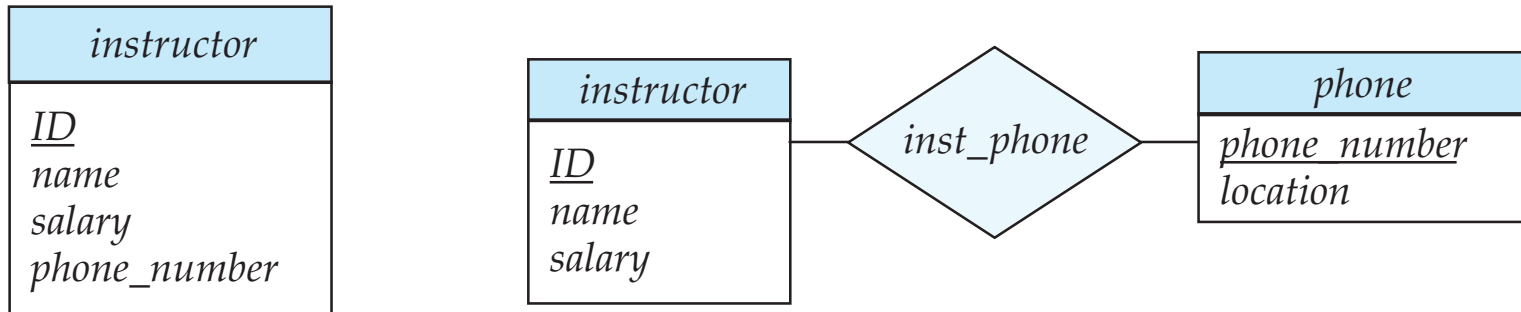

- Designing phone as an entity allow for primary key constraints for phone
- Designing phone as an entity allow phone numbers to be used in relationships with other entities (e.g., student)
- Use of phone as an entity allows extra information about phone numbers



# Design Issues

## ■ Use of entity sets vs. relationship sets

- Possible guideline is to designate a relationship set to describe an action that occurs between entities
- Possible hint: the relationship only relates entities, but does not have an existence by itself. E.g., hasAddress: (department-address)

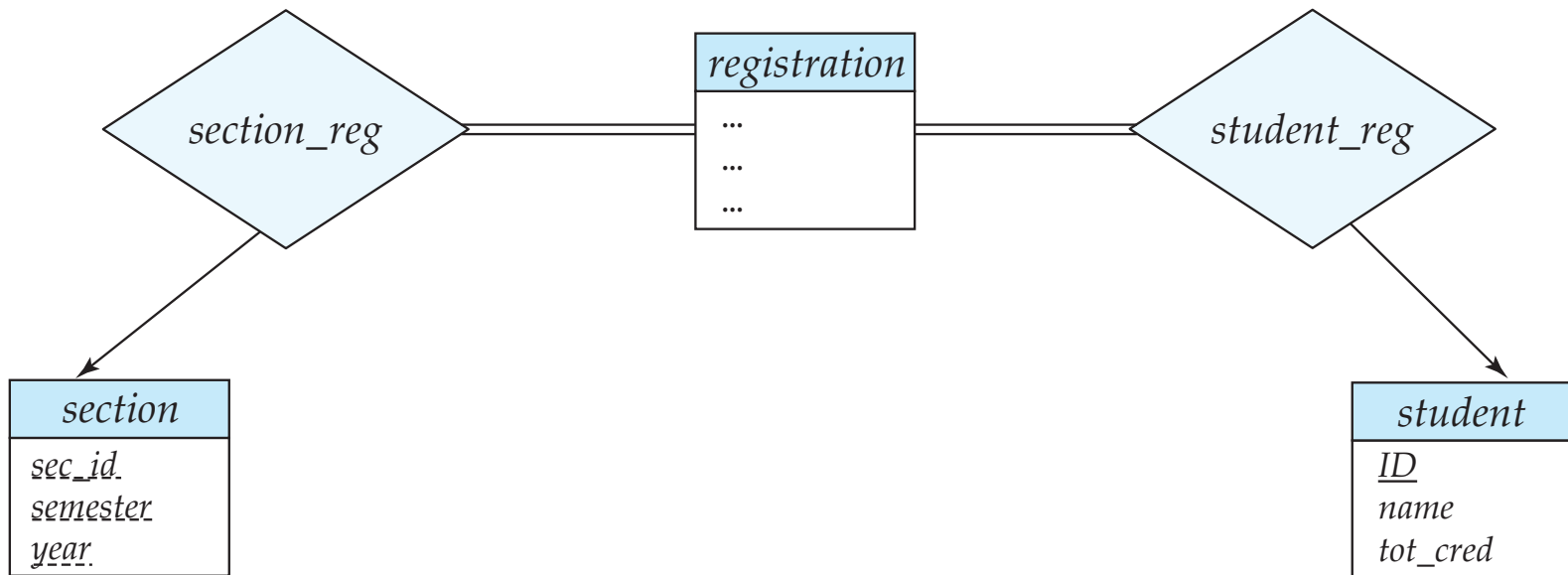



# Design Issues

## ■ Binary versus n-ary relationship sets

- Although it is possible to replace any nonbinary ( $n$ -ary, for  $n > 2$ ) relationship set by a number of distinct binary relationship sets + an artificial entity set, a  $n$ -ary relationship set shows more clearly that several entities participate in a single relationship.

## ■ Placement of relationship attributes

- e.g., attribute *date* as attribute of *advisor* or as attribute of *student*
- Does not work for *N-M relationships!*



# Binary Vs. Non-Binary Relationships

- Some relationships that appear to be non-binary may be better represented using binary relationships
  - E.g., A ternary relationship *parents*, relating a child to his/her father and mother, is best replaced by two binary relationships, *father* and *mother*
    - ▶ Using two binary relationships allows partial information (e.g., only mother being know)
  - But there are some relationships that are naturally non-binary
    - ▶ Example: *proj\_guide*



# Converting Non-Binary Relationships to Binary Form

- In general, any non-binary relationship can be represented using binary relationships by creating an artificial entity set.
  - Replace  $R$  between entity sets  $A$ ,  $B$  and  $C$  by an entity set  $E$ , and three relationship sets:
    1.  $R_A$ , relating  $E$  and  $A$
    2.  $R_B$ , relating  $E$  and  $B$
    3.  $R_C$ , relating  $E$  and  $C$
  - Create a special identifying attribute for  $E$
  - Add any attributes of  $R$  to  $E$
  - For each relationship  $(a_i, b_i, c_i)$  in  $R$ , create
    1. a new entity  $e_i$  in the entity set  $E$
    2. add  $(e_i, a_i)$  to  $R_A$
    3. add  $(e_i, b_i)$  to  $R_B$
    4. add  $(e_i, c_i)$  to  $R_C$

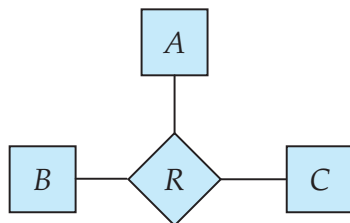

(a)

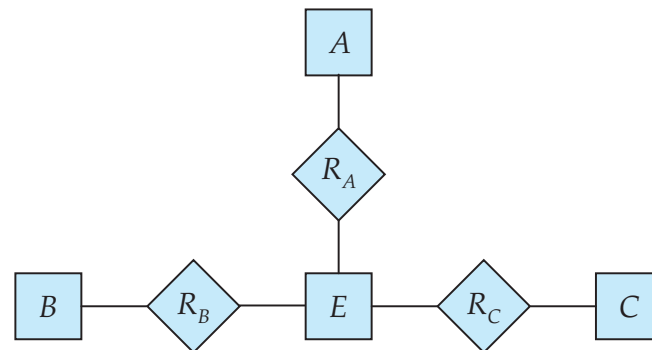

(b)



# Converting Non-Binary Relationships (Cont.)

- Also need to translate constraints
  - Translating all constraints may not be possible
  - There may be instances in the translated schema that cannot correspond to any instance of  $R$ 
    - ▶ Exercise: *add constraints to the relationships  $R_A$ ,  $R_B$  and  $R_C$  to ensure that a newly created entity corresponds to exactly one entity in each of entity sets  $A$ ,  $B$  and  $C$*
  - We can avoid creating an identifying attribute by making  $E$  a weak entity set (described shortly) identified by the three relationship sets



# Converting Non-Binary Relationships: Is the New Entity Set E Necessary?

- Yes, because a non-binary relationship stores more information than any number of binary relationships

- Consider again the example (a) below

- Replace R with three binary relationships:

1.  $R_{AB}$ , relating A and B

2.  $R_{BC}$ , relating B and C

3.  $R_{AC}$ , relating A and C

- For each relationship  $(a_i, b_i, c_i)$  in R, create

- ▶ 1. add  $(a_i, b_i)$  to  $R_{AB}$

- ▶ 2. add  $(b_i, c_i)$  to  $R_{BC}$

- ▶ 3. add  $(a_i, c_i)$  to  $R_{AC}$

- Consider  $R = \text{order}$ ,  $A = \text{supplier}$ ,  $B = \text{item}$ ,  $C = \text{customer}$

*(Gunnar, chainsaw, Bob)* – Bob ordered a chainsaw from Gunnar

->

*(Gunnar, chainsaw)*, *(chainsaw, Bob)*, *(Gunnar, Bob)*

*Gunnar supplies chainsaws, Bob ordered a chainsaw, Bob ordered something from Gunnar. E.g., we do not know what Bob ordered from Gunnar.*

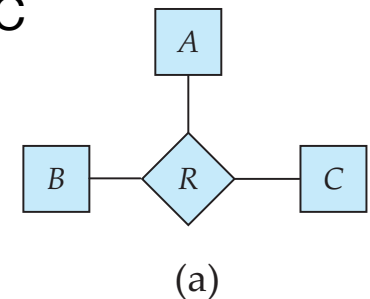





# ER-model to Relational Summary

- **Rule 1) Strong entity  $E$** 
  - Create relation with attributes of  $E$
  - Primary key is equal to the PK of  $E$
- **Rule 2) Weak entity  $W$  identified by  $E$  through relationship  $R$** 
  - Create relation with attributes of  $W$  and  $R$  and PK( $E$ ).
  - Set PK to discriminator attributes combined with PK( $E$ ). PK( $E$ ) is a foreign key to  $E$ .
- **Rule 3) Binary relationship  $R$  between  $A$  and  $B$ : one-to-one**
  - If no side is total add PK of  $A$  to as foreign key in  $B$  or the other way around. Add any attributes of the relationship  $R$  to  $A$  respective  $B$ .
  - If one side is total add PK of the other-side as foreign key. Add any attributes of the relationship  $R$  to the total side.
  - If both sides are total merge the two relation into a new relation  $E$  and choose either PK( $A$ ) as PK( $B$ ) as the new PK. Add any attributes of the relationship  $R$  to the new relation  $E$ .



## ER-model to Relational Summary (Cont.)

- **Rule 4)** Binary relationship  $R$  between  $A$  and  $B$ : one-to-many/many-to-one
  - Add PK of the “one” side as foreign key to the “many” side.
  - Add any attributes of the relationship  $R$  to the “many” side.
- **Rule 5)** Binary relationship  $R$  between  $A$  and  $B$ : many-to-many
  - Create a new relation  $R$ .
  - Add PK's of  $A$  and  $B$  as attributes + plus all attributes of  $R$ .
  - The primary key of the relationship is  $PK(A) + PK(B)$ . The PK attributes of  $A/B$  form a foreign key to  $A/B$
- **Rule 6)** N-ary relationship  $R$  between  $E_1 \dots E_n$ 
  - Create a new relation.
  - Add all the PK's of  $E_1 \dots E_n$ . Add all attributes of  $R$  to the new relation.
  - The primary key of  $R$  is  $PK(E_1) \dots PK(E_n)$ . Each  $PK(E_i)$  is a foreign key to the corresponding relation.



## ER-model to Relational Summary (Cont.)

- **Rule 7)** Entity  $E$  with multi-valued attribute  $A$ 
  - Create new relation. Add  $A$  and  $PK(E)$  as attributes.
  - $PK$  is all attributes.  $PK(E)$  is a foreign key.



# E-R Diagram for a University Enterprise

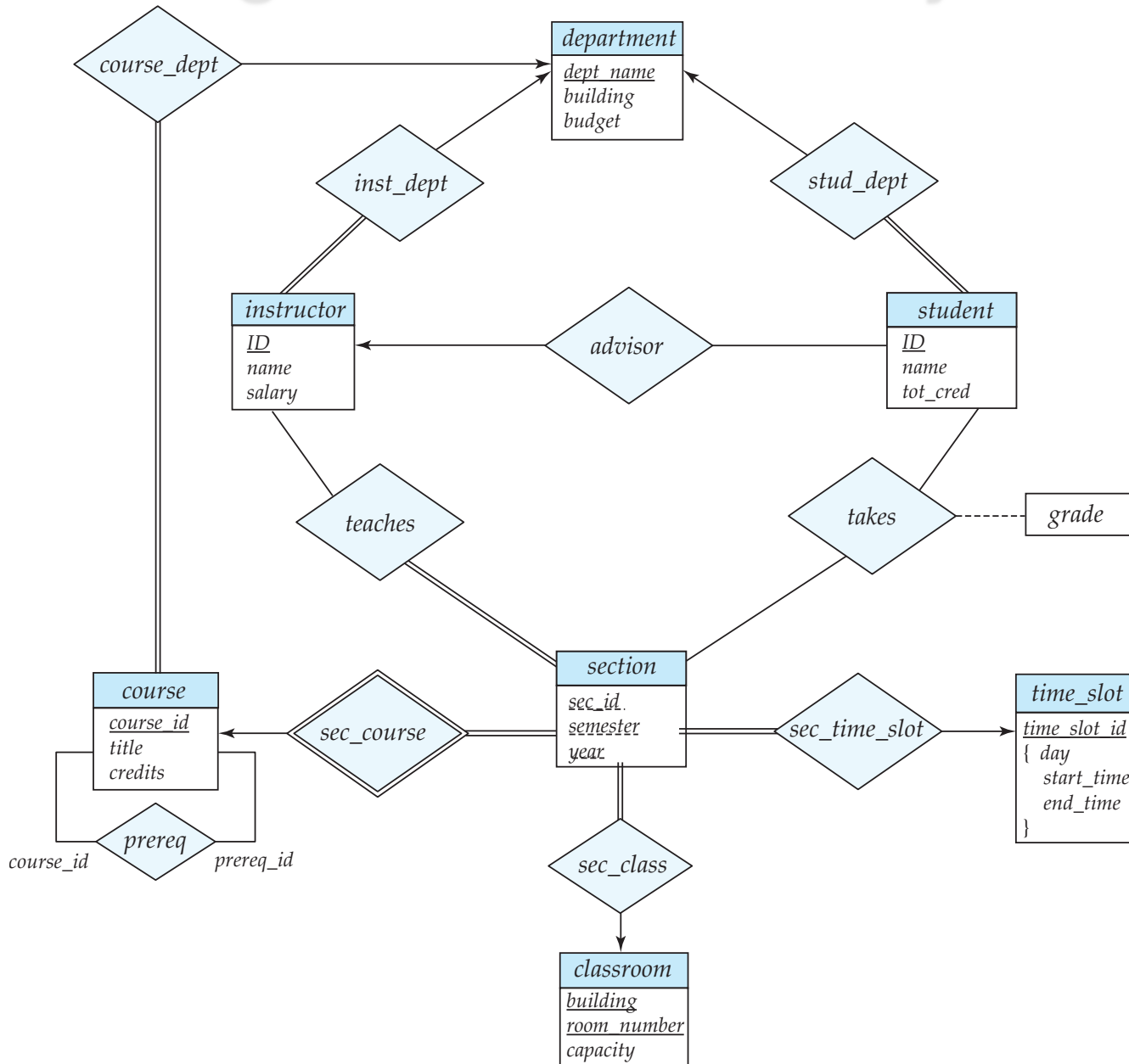



# Translate the University ER-Model

## ■ Rule 1) Strong Entities

- **department**(dept\_name, building, budget)
- **instructor**(ID, name, salary)
- **student**(ID, name, tot\_cred)
- **course**(course\_id, title, credits)
- **time\_slot**(time\_slot\_id)
- **classroom**(building, room\_number, capacity)

## ■ Rule 2) Weak Entities

- **section**(course\_id, sec\_id, semester, year)

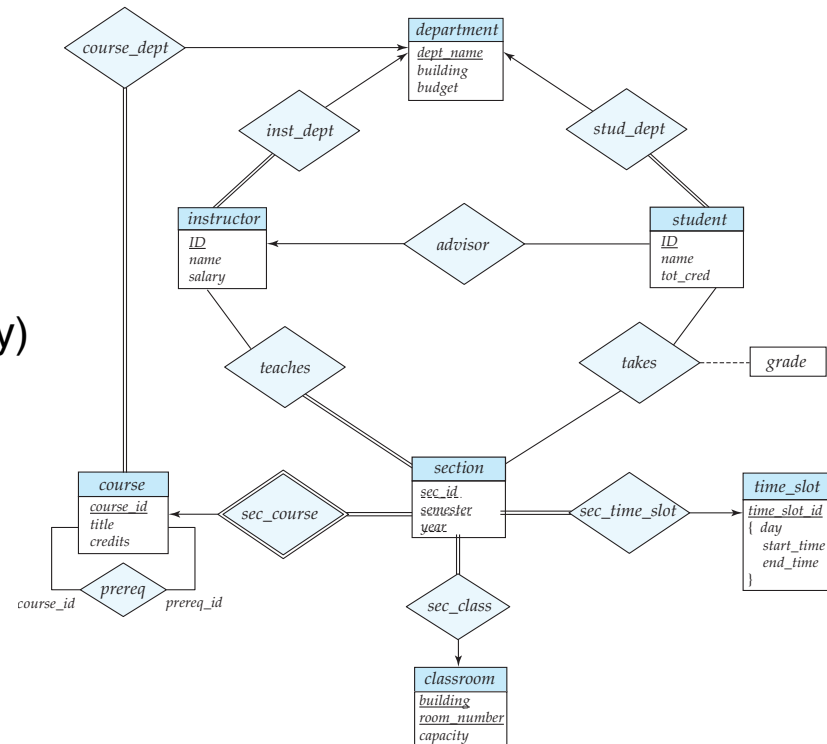



# Translate the University ER-Model

## ■ Rule 3) Relationships one-to-one

- None exist

## ■ Rule 4) Relationships one-to-many

- **department**(dept\_name, building, budget)
- **instructor**(ID, name, salary, **dept\_name**)
- **student**(ID, name, tot\_cred, **dept\_name**, **instr\_ID**)
- **course**(course\_id, title, credits, **dept\_name**)
- **time\_slot**(time\_slot\_id)
- **classroom**(building, room\_number, capacity)
- **section**(course\_id, sec\_id, semester, year, **room\_building**, **room\_number**, **time\_slot\_id**)

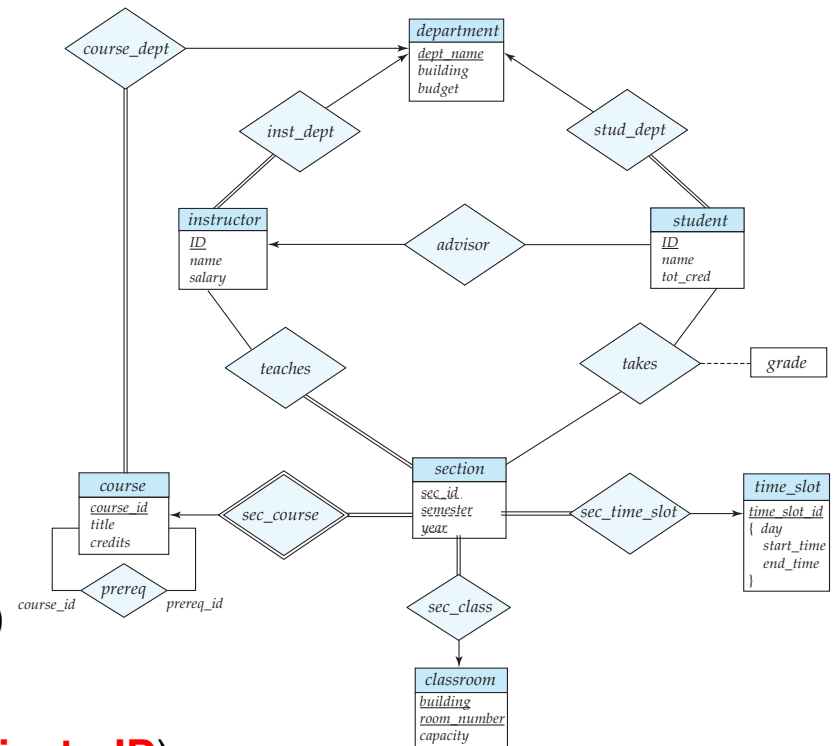



# Translate the University ER-Model

## ■ Rule 5) Relationships many-to-many

- **department**(dept\_name, building, budget)
- **instructor**(ID, name, salary, dept\_name)
- **student**(ID, name, tot\_cred, dept\_name, instr\_ID)
- **course**(course\_id, title, credits, dept\_name)
- **time\_slot**(time\_slot\_id)
- **classroom**(building, room\_number, capacity)
- **section**(course\_id, sec\_id, semester, year, room\_building, room\_number, time\_slot\_id)
- **prereq**(course\_id, prereq\_id)
- **teaches**(ID, course\_id, sec\_id, semester, year)
- **takes**(ID, course\_id, sec\_id, semester, year, grade)

## ■ Rule 6) N-ary Relationships

- none exist

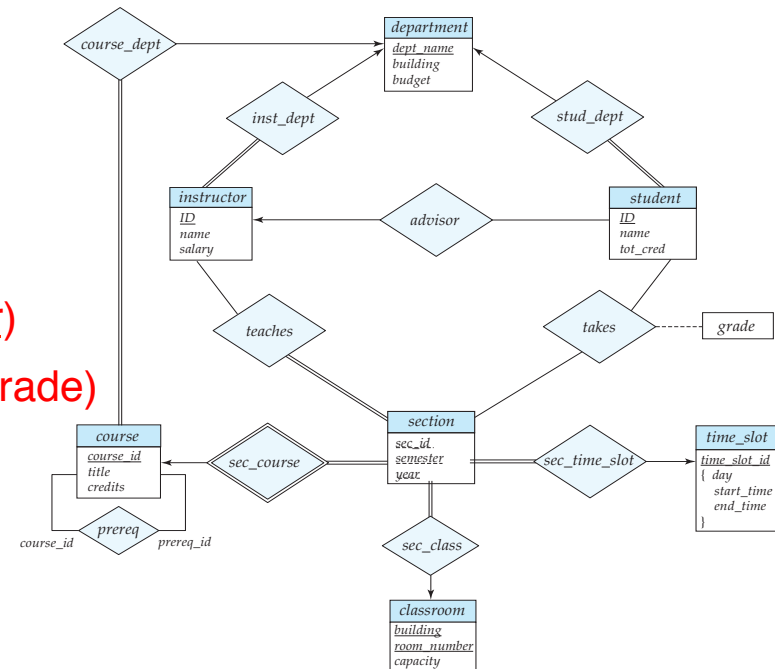



# Translate the University ER-Model

## ■ Rule 7) Multivalued attributes

- **department**(dept\_name, building, budget)
- **instructor**(ID, name, salary, dept\_name)
- **student**(ID, name, tot\_cred, dept\_name, instr\_ID)
- **course**(course\_id, title, credits, dept\_name)
- **time\_slot**(time\_slot\_id)
- **time\_slot\_day**(time\_slot\_id, start time, end time)
- **classroom**(building, room number, capacity)
- **section**(course\_id, sec\_id, semester, year, room\_building, room\_number, time\_slot\_id)
- **prereq**(course\_id, prereq\_id)
- **teaches**(ID, course\_id, sec\_id, semester, year)
- **takes**(ID, course\_id, sec\_id, semester, year, grade)

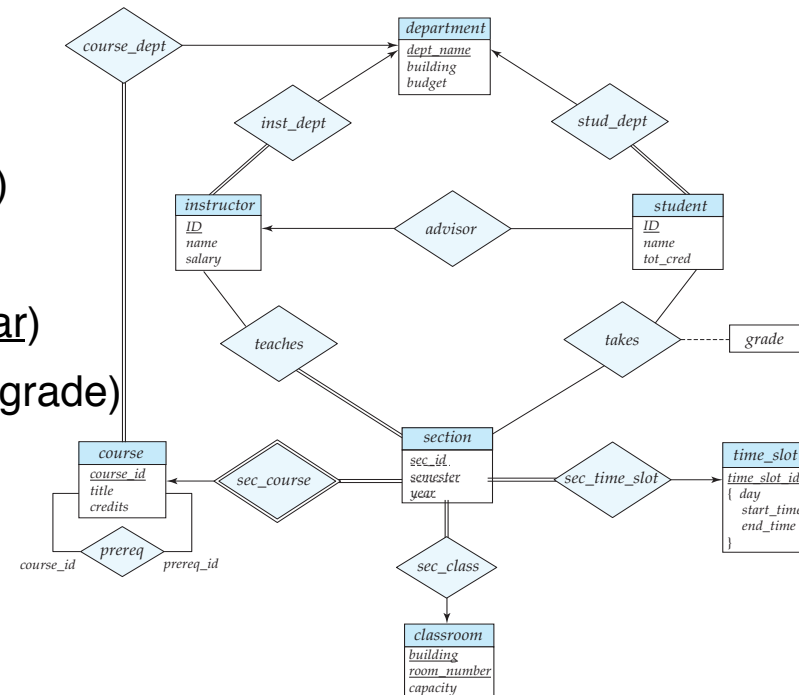





# Extended ER Features



# Extended E-R Features: Specialization

- Top-down design process; we designate subgroupings within an entity set that are distinctive from other entities in the set.
- These subgroupings become lower-level entity sets that have attributes or participate in relationships that do not apply to the higher-level entity set.
- Depicted by a *triangle* component labeled ISA (E.g., *instructor* “is a” *person*).
- **Attribute inheritance** – a lower-level entity set inherits all the attributes and relationship participation of the higher-level entity set to which it is linked.



# Specialization Example

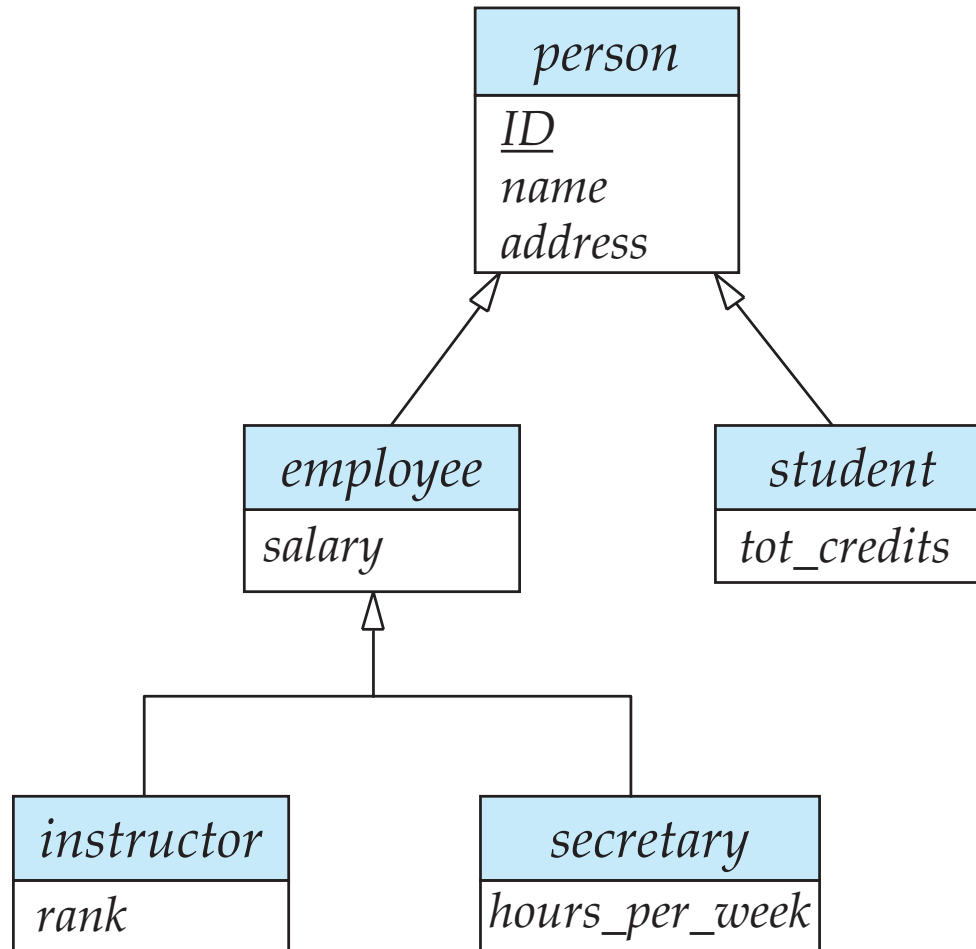



# Extended ER Features: Generalization

- **A bottom-up design process** – combine a number of entity sets that share the same features into a higher-level entity set.
- Specialization and generalization are simple inversions of each other; they are represented in an E-R diagram in the same way.
- The terms specialization and generalization are used interchangeably.



# Specialization and Generalization (Cont.)

- Can have multiple specializations of an entity set based on different features.
- E.g., *permanent\_employee* vs. *temporary\_employee*, in addition to *instructor* vs. *secretary*
- Each particular employee would be
  - a member of one of *permanent\_employee* or *temporary\_employee*,
  - and also a member of one of *instructor*, *secretary*
- The ISA relationship also referred to as **superclass - subclass** relationship



# Design Constraints on a Specialization/Generalization

- Constraint on which entities can be members of a given lower-level entity set.
  - condition-defined
    - ▶ Example: all customers over 65 years are members of *senior-citizen* entity set; *senior-citizen* ISA *person*.
  - user-defined
- Constraint on whether or not entities may belong to more than one lower-level entity set within a single generalization.
  - **Disjoint**
    - ▶ an entity can belong to only one lower-level entity set
    - ▶ Noted in E-R diagram by having multiple lower-level entity sets link to the same triangle
  - **Overlapping**
    - ▶ an entity can belong to more than one lower-level entity set



# Specialization Example

**Disjoint**, employees are either instructors or secretaries

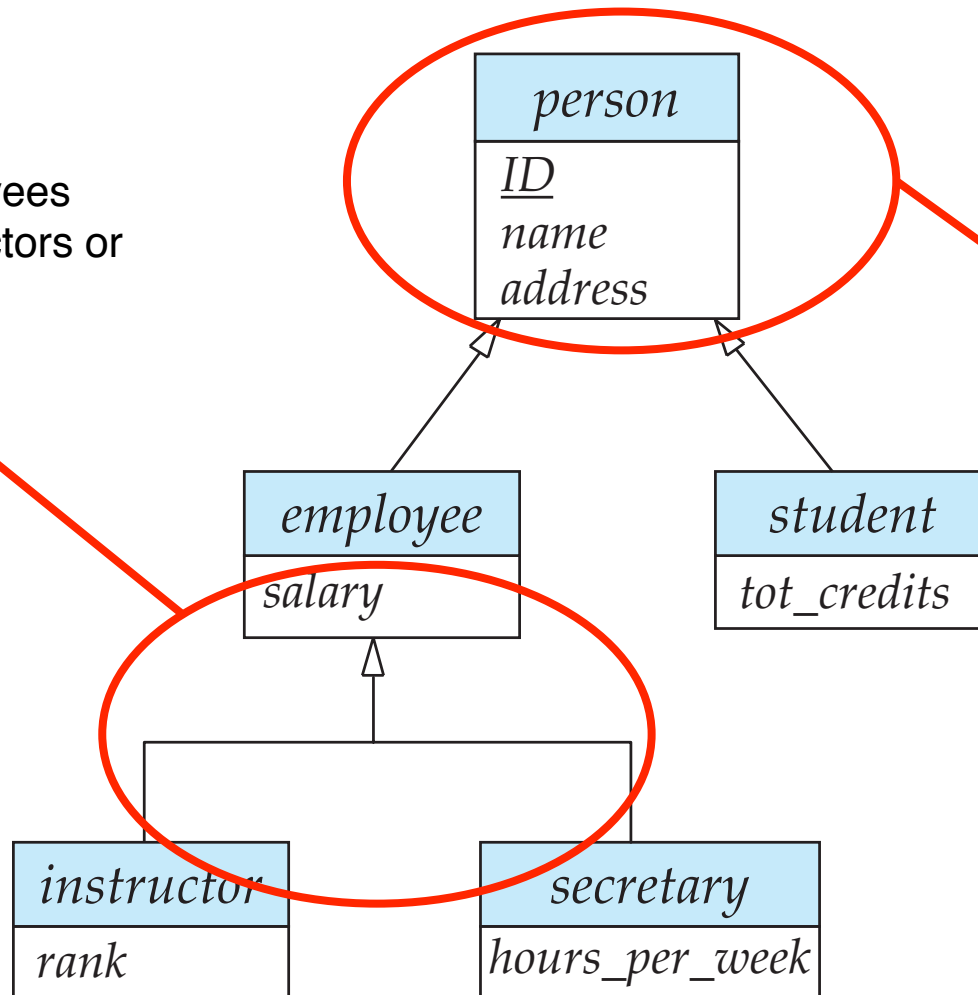

**Overlapping**, a person can be both an employee and a student



# Design Constraints on a Specialization/Generalization (Cont.)

- **Completeness constraint** -- specifies whether or not an entity in the higher-level entity set must belong to at least one of the lower-level entity sets within a generalization.
  - **total**: an entity must belong to one of the lower-level entity sets
  - **partial**: an entity need not belong to one of the lower-level entity sets





# Aggregation

- Consider the ternary relationship *proj\_guide*, which we saw earlier
- Suppose we want to record evaluations of a student by a guide on a project

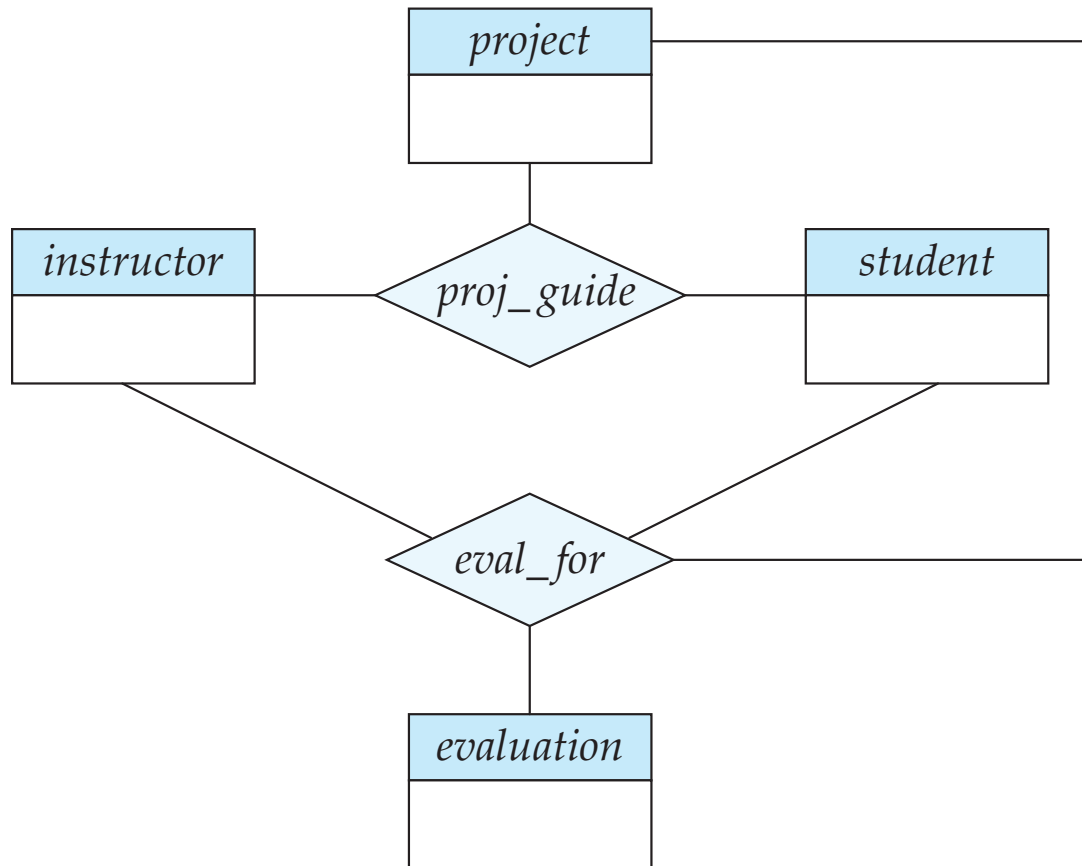



# Aggregation (Cont.)

- Relationship sets *eval\_for* and *proj\_guide* represent overlapping information
  - Every *eval\_for* relationship corresponds to a *proj\_guide* relationship
  - However, some *proj\_guide* relationships may not correspond to any *eval\_for* relationships
    - ▶ So we can't discard the *proj\_guide* relationship
- Eliminate this redundancy via *aggregation*
  - Treat relationship as an abstract entity
  - Allows relationships between relationships
  - Abstraction of relationship into new entity



# Aggregation (Cont.)

- Without introducing redundancy, the following diagram represents:
  - A student is guided by a particular instructor on a particular project
  - A student, instructor, project combination may have an associated evaluation

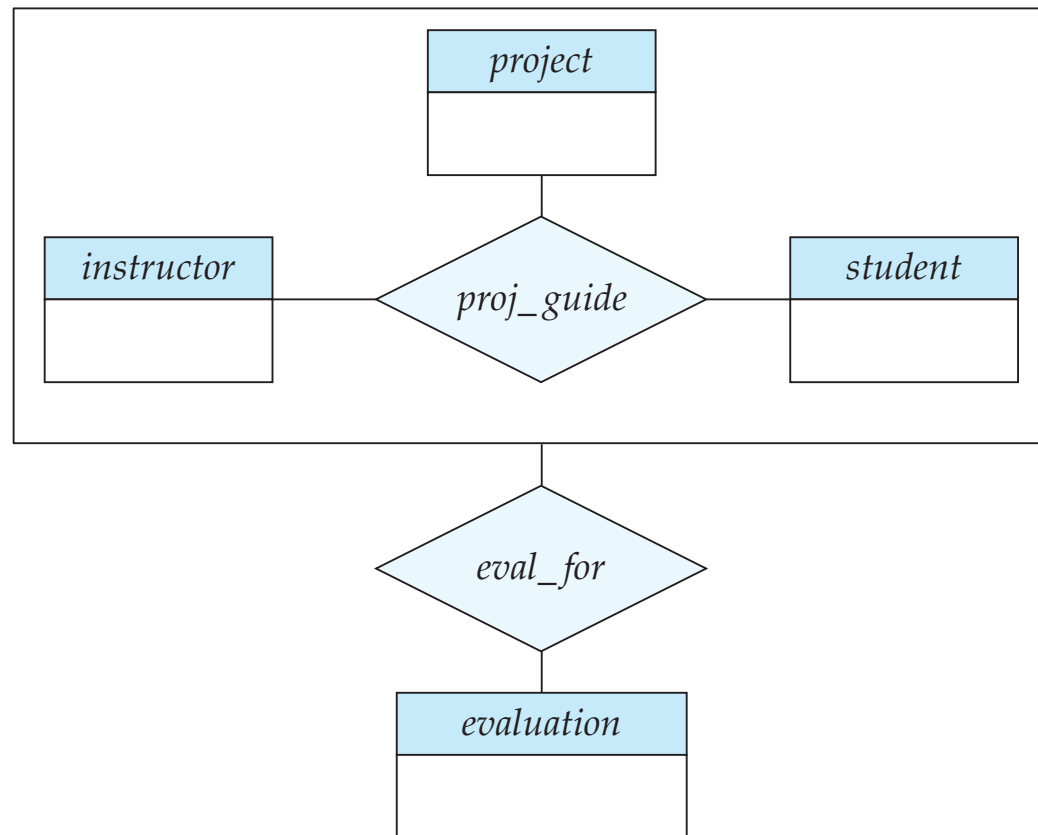



# Representing Specialization via Schemas

## ■ Method 1:

- Form a relation schema for the higher-level entity
- Form a relation schema for each lower-level entity set, include primary key of higher-level entity set and local attributes

<u>schema</u>	<u>attributes</u>
<i>person</i>	<i>ID, name, street, city</i>
<i>student</i>	<i>ID, tot_cred</i>
<i>employee</i>	<i>ID, salary</i>

- Drawback: getting information about, an *employee* requires accessing two relations, the one corresponding to the low-level schema and the one corresponding to the high-level schema



# Representing Specialization as Schemas (Cont.)

## ■ Method 2:

- Form a single relation schema for each entity set with all local and inherited attributes

schema	attributes
<i>person</i>	<i>ID, name, street, city</i>
<i>student</i>	<i>ID, name, street, city, tot_cred</i>
<i>employee</i>	<i>ID, name, street, city, salary</i>

- If specialization is total, the schema for the generalized entity set (*person*) not required to store information
  - ▶ Can be defined as a “view” relation containing union of specialization relations
  - ▶ But explicit schema may still be needed for foreign key constraints
- Drawback: *name, street* and *city* may be stored redundantly for people who are both students and employees



# Representing Specialization as Schemas (Cont.)

## ■ Method 3:

- Form a single relation schema for each entity set with all local and inherited attributes
  - ▶ For total and disjoint specialization add a single “type” attribute that stores the type of an entity

schema	attributes
<i>person</i>	<i>ID, <b>type</b>, name, street, city, tot_cred, salary</i>

- ▶ For partial and/or overlapping specialization add multiple boolean “type” attributes

schema	attributes
<i>person</i>	<i>ID, <b>isEmployee</b>, <b>isStudent</b>, name, street, city, tot_cred, salary</i>

- Drawback: large number of NULL values, potentially large relation



# Schemas Corresponding to Aggregation

- To represent aggregation, create a schema containing
  - primary key of the aggregated relationship,
  - the primary key of the associated entity set
  - any descriptive attributes



# Schemas Corresponding to Aggregation (Cont.)

- For example, to represent aggregation manages between relationship works\_on and entity set manager, create a schema *eval\_for* (*s\_ID*, *project\_id*, *i\_ID*, *evaluation\_id*)

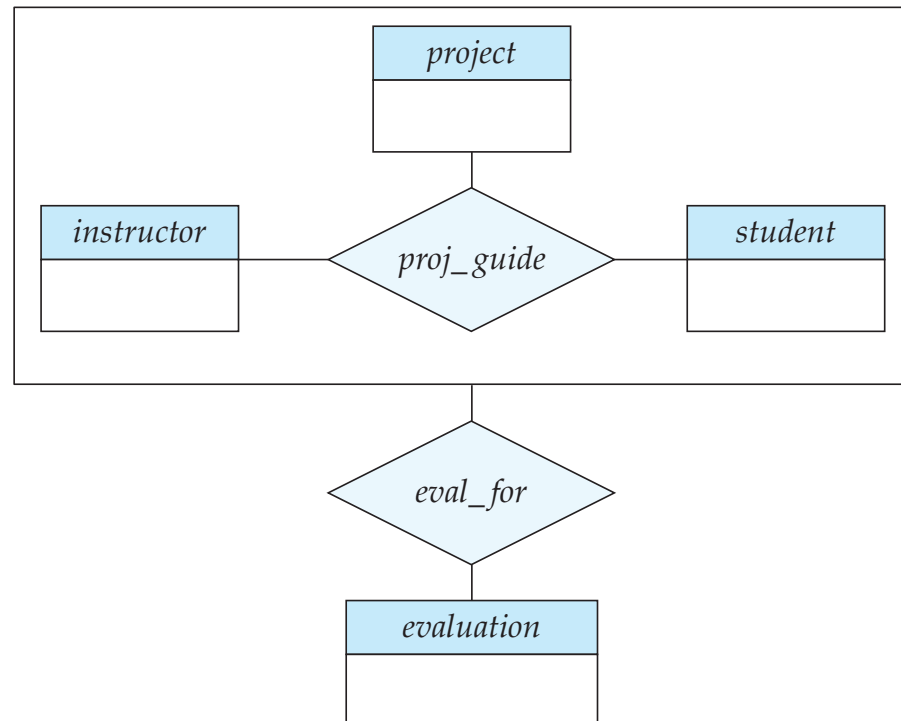





## ER-model to Relational Summary (Cont.)

- **Rule 8)** Specialization of  $E$  into  $S_1, \dots, S_n$  (method 1)
  - Create a relation for  $E$  with all attributes of  $E$ . The PK of  $E$  is the PK.
  - For each  $S_i$  create a relation with  $PK(E)$  as PK and foreign key to relation for  $E$ . Add all attributes of  $S_i$  that do not exist in  $E$ .
- **Rule 9)** Specialization of  $E$  into  $S_1, \dots, S_n$  (method 2)
  - Create a relation for  $E$  with all attributes of  $E$ . The PK of  $E$  is the PK.
  - For each  $S_i$  create a relation with  $PK(E)$  as PK and foreign key to relation for  $E$ . Add all attributes of  $S_i$ .
- **Rule 10)** Specialization of  $E$  into  $S_1, \dots, S_n$  (method 3)
  - Create a new relation with all attributes from  $E$  and  $S_1, \dots, S_n$ .
  - Add single attribute type or a boolean type attribute for each  $S_i$
  - The primary key is  $PK(E)$



## ER-model to Relational Summary (Cont.)

- **Rule 11) Aggregation:** Relationship  $R_1$  relates entity sets  $E_1, \dots, E_n$ . This is related by relationship  $A$  to an entity set  $B$ 
  - Create a relation for  $A$  with attributes  $PK(E_1) \dots PK(E_n) +$  all attributes from  $A + PK(B)$ .  $PK$  are all attributes except the ones from  $A$



# ER Design Decisions

- The use of an attribute or entity set to represent an object.
- Whether a real-world concept is best expressed by an entity set or a relationship set.
- The use of a ternary relationship versus a pair of binary relationships.
- The use of a strong or weak entity set.
- The use of specialization/generalization – contributes to modularity in the design.
- The use of aggregation – can treat the aggregate entity set as a single unit without concern for the details of its internal structure.



# How about doing another ER design interactively on the board?

Partially taken from  
Klaus R. Dittrich

modified from:

**Database System Concepts, 6<sup>th</sup> Ed.**

©Silberschatz, Korth and Sudarshan  
See [www.db-book.com](http://www.db-book.com) for conditions on re-use



# Summary of Symbols Used in E-R Notation

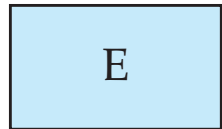

entity set

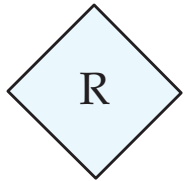

relationship set

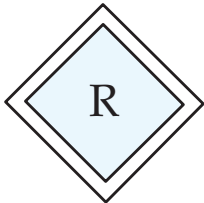

identifying  
relationship set  
for weak entity set

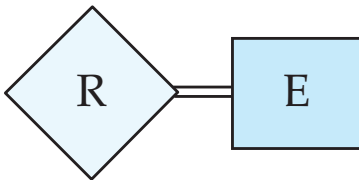

total participation  
of entity set in  
relationship

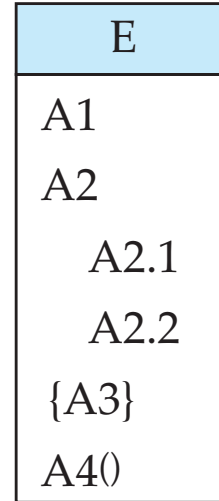

attributes:  
simple (A1),  
composite (A2) and  
multivalued (A3)  
derived (A4)

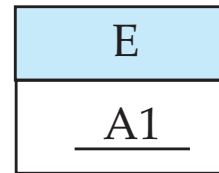

primary key

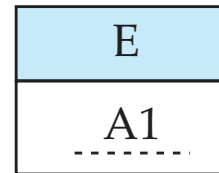

discriminating  
attribute of  
weak entity set



# Symbols Used in ER Notation (Cont.)

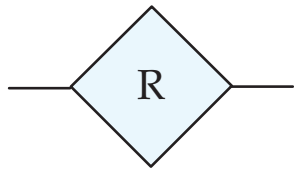

many-to-many relationship

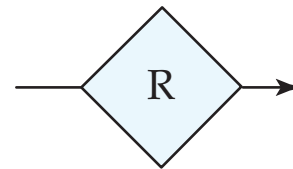

many-to-one relationship

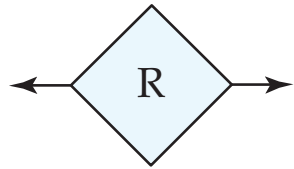

one-to-one relationship

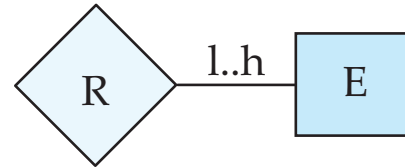

cardinality limits

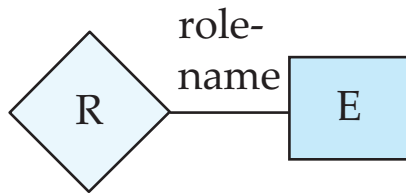

role indicator

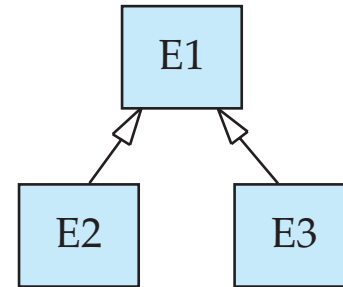

ISA: generalization or specialization

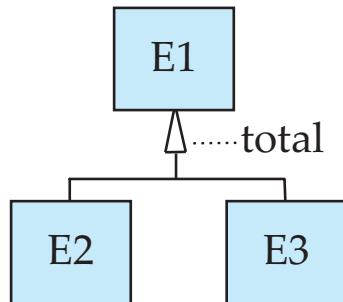

total (disjoint) generalization

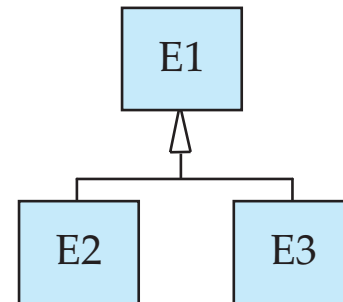

disjoint generalization



# Alternative ER Notations

## ■ Chen, IDE1FX, ...

entity set E with  
simple attribute A1,  
composite attribute A2,  
multivalued attribute A3,  
derived attribute A4,  
and primary key A1

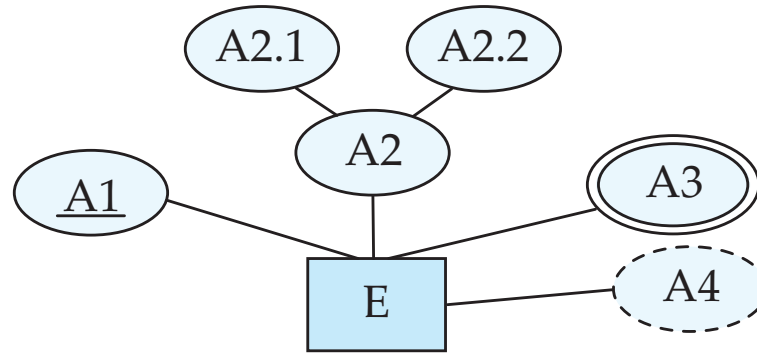

weak entity set



generalization



total  
generalization





# Alternative ER Notations

## Chen

## IDE1FX (Crows feet notation)

many-to-many  
relationship

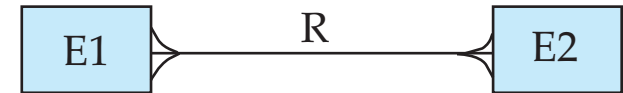
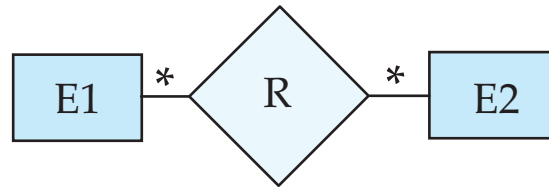

one-to-one  
relationship

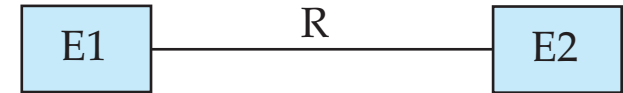
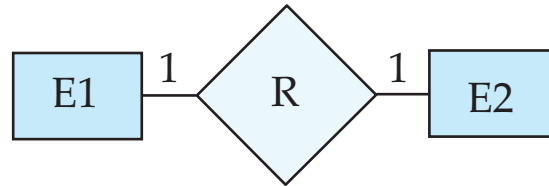

many-to-one  
relationship

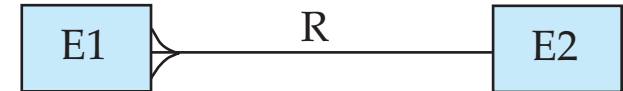
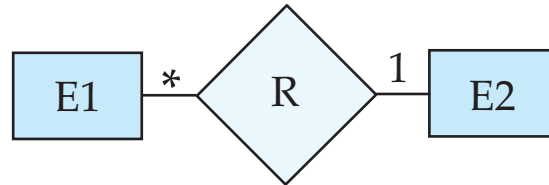

participation  
in R: total (E1)  
and partial (E2)

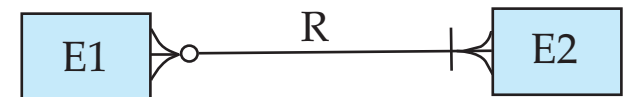
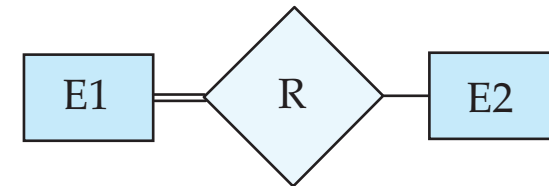





# UML

- **UML**: Unified Modeling Language
- UML has many components to graphically model different aspects of an entire software system
- UML Class Diagrams correspond to E-R Diagram, but several differences.



# ER vs. UML Class Diagrams

## ER Diagram Notation

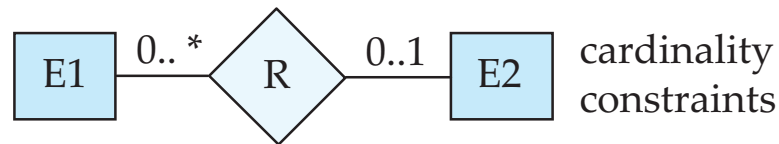
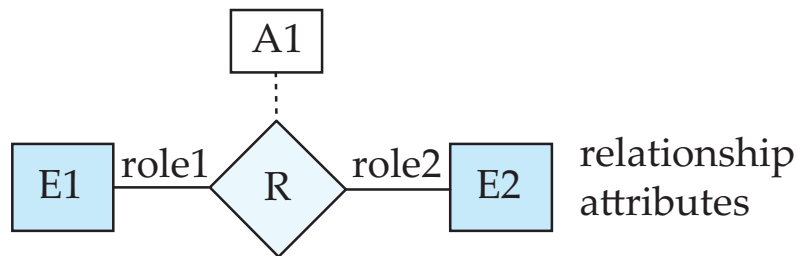
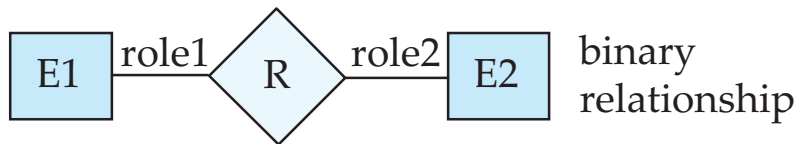
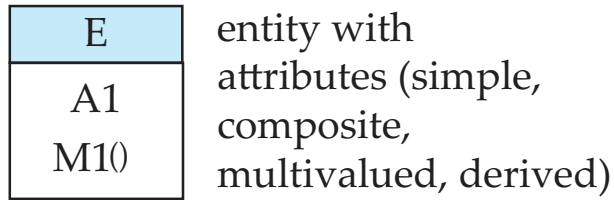

## Equivalent in UML

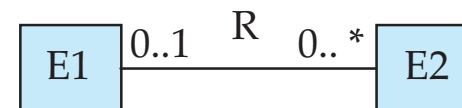
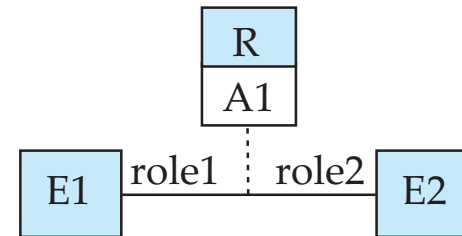
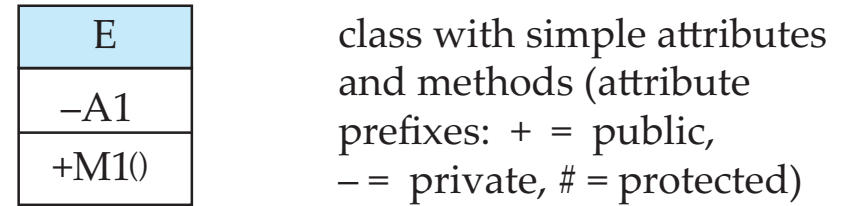

\*Note reversal of position in cardinality constraint depiction



# ER vs. UML Class Diagrams

## ER Diagram Notation

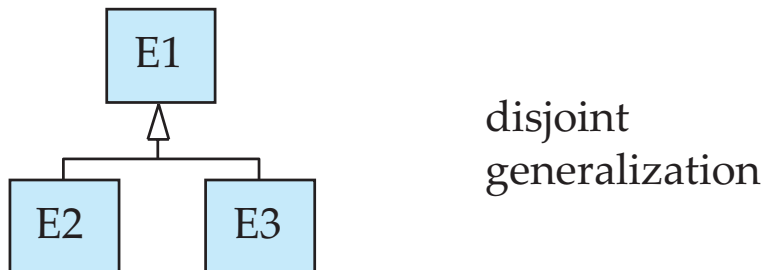
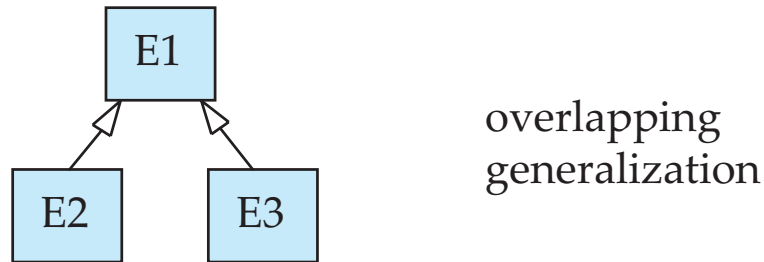
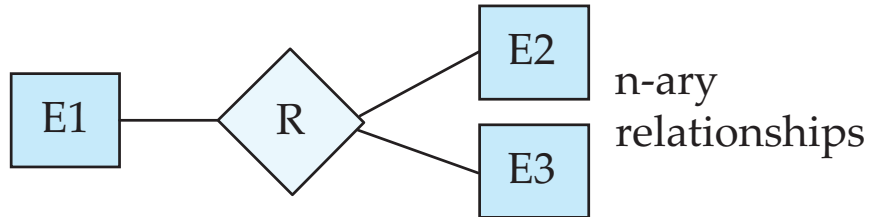

## Equivalent in UML

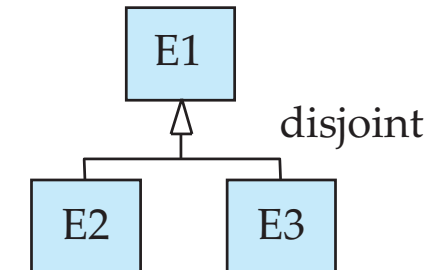
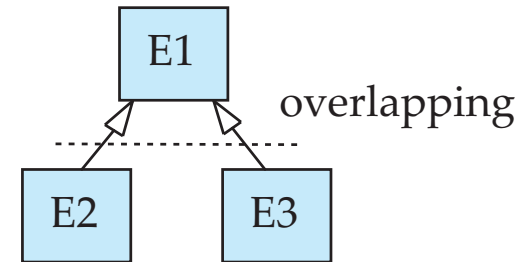
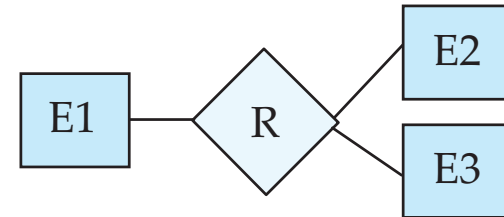

\*Generalization can use merged or separate arrows independent of disjoint/overlapping



# UML Class Diagrams (Cont.)

- Binary relationship sets are represented in UML by just drawing a line connecting the entity sets. The relationship set name is written adjacent to the line.
- The role played by an entity set in a relationship set may also be specified by writing the role name on the line, adjacent to the entity set.
- The relationship set name may alternatively be written in a box, along with attributes of the relationship set, and the box is connected, using a dotted line, to the line depicting the relationship set.



# Recap

- ER-model
  - Entities
    - ▶ Strong
    - ▶ Weak
  - Attributes
    - ▶ Simple vs. Composite
    - ▶ Single-valued vs. Multi-valued
  - Relationships
    - ▶ Degree (binary vs. N-ary)
  - Cardinality constraints
  - Specialization/Generalization
    - ▶ Total vs. partial
    - ▶ Disjoint vs. overlapping
  - Aggregation



# Recap Cont.

- ER-Diagrams
  - Alternative notations
- UML-Diagrams
- Design decisions
  - Multi-valued attribute vs. entity
  - Entity vs. relationship
  - Binary vs. N-ary relationships
  - Placement of relationship attributes
  - Total 1-1 vs. single entity
- ER to relational model
  - Translation rules



# End of Chapter 7

**Partially taken from**

**Klaus R. Dittrich**

**modified from:**

**Database System Concepts, 6<sup>th</sup> Ed.**

©Silberschatz, Korth and Sudarshan

See [www.db-book.com](http://www.db-book.com) for conditions on re-use



# Outline

- Introduction
- Relational Data Model
- Formal Relational Languages (relational algebra)
- SQL - Advanced
- **Database Design – Database modelling**
- Transaction Processing, Recovery, and Concurrency Control
- Storage and File Structures
- Indexing and Hashing
- Query Processing and Optimization





# Figure 7.01

76766	Crick
45565	Katz
10101	Srinivasan
98345	Kim
76543	Singh
22222	Einstein

*instructor*

98988	Tanaka
12345	Shankar
00128	Zhang
76543	Brown
76653	Aoi
23121	Chavez
44553	Peltier

*student*



# Figure 7.02

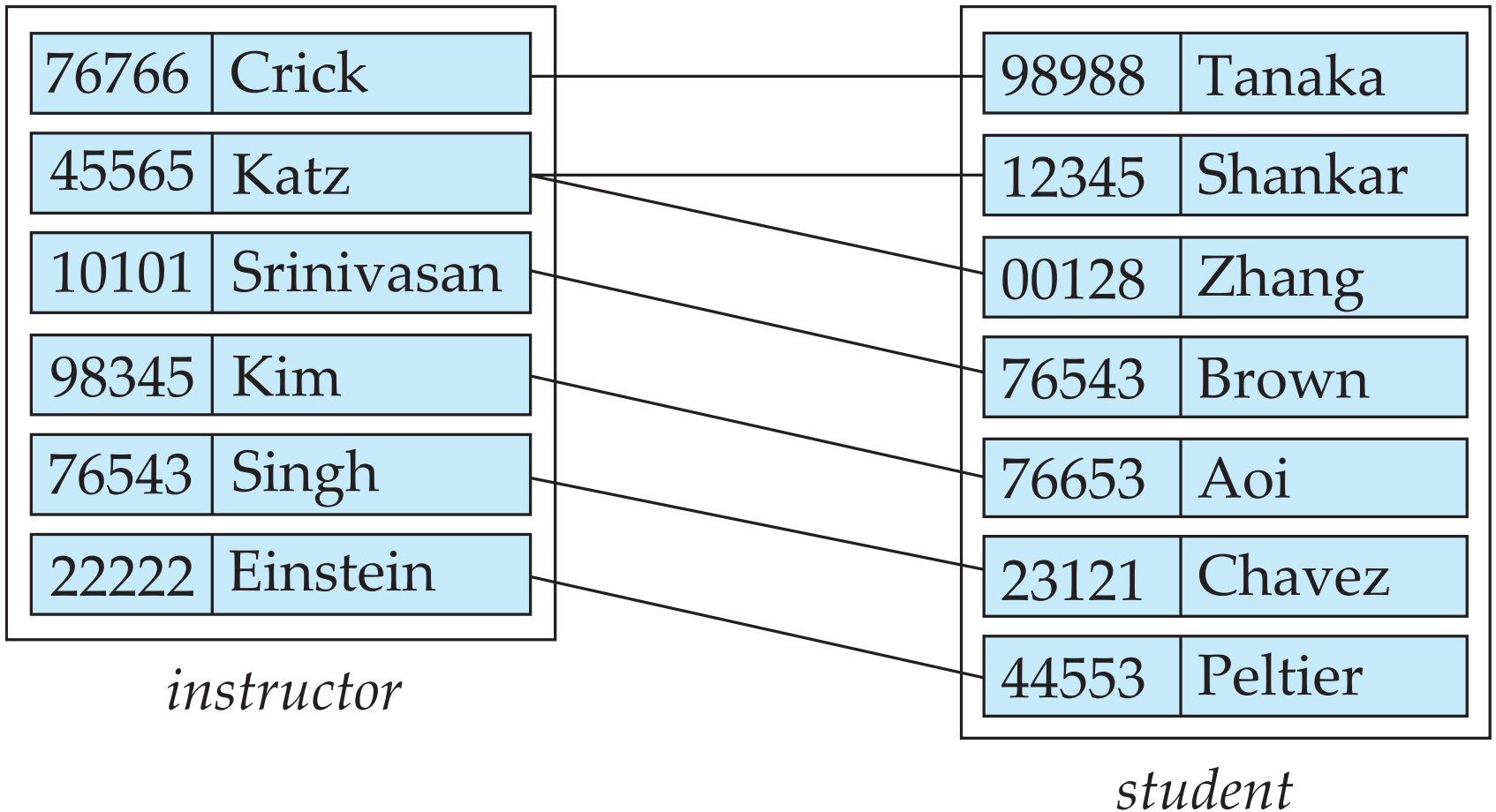



# Figure 7.03

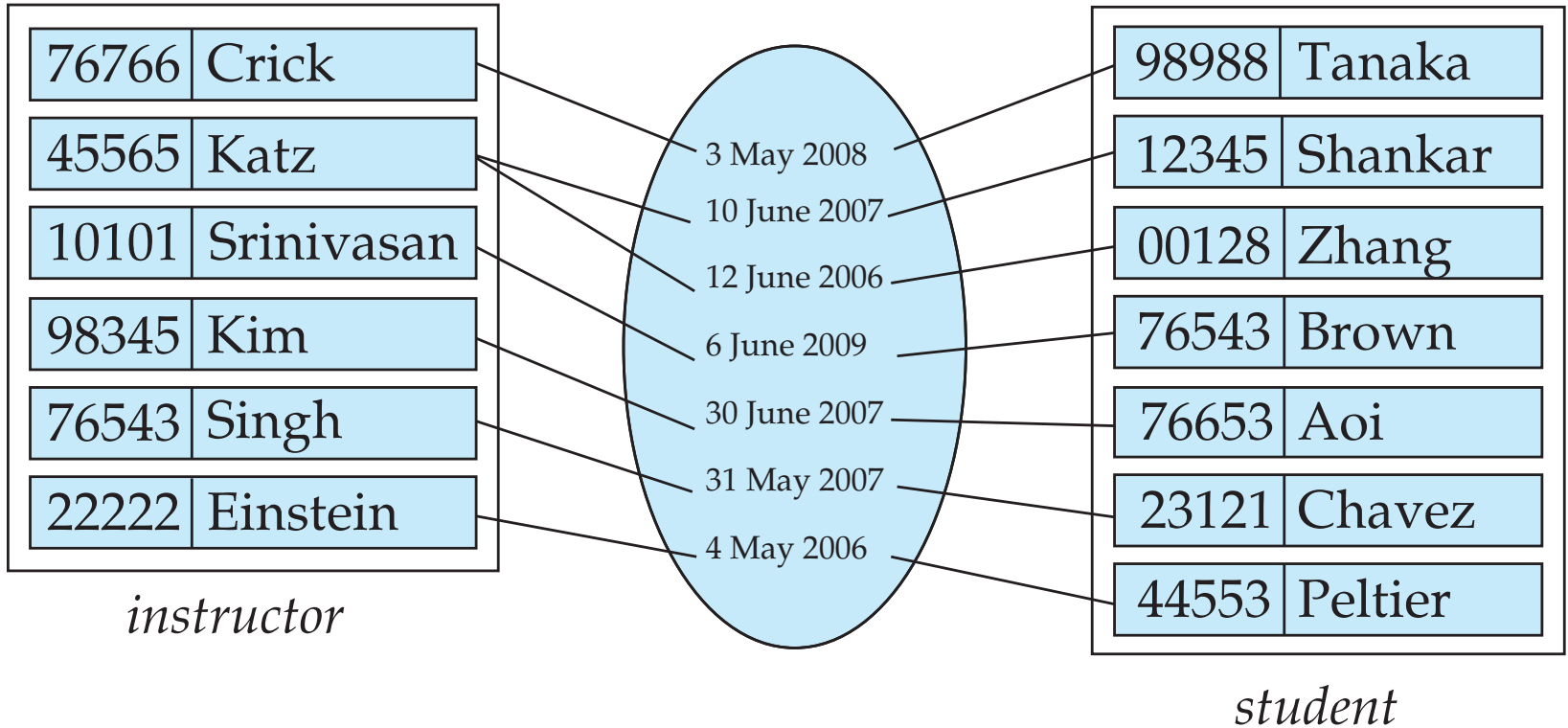



# Figure 7.04

composite  
attributes

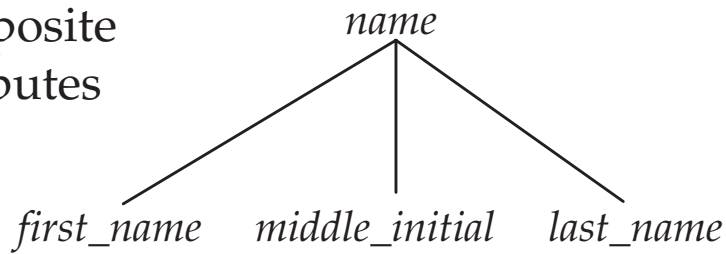

component  
attributes

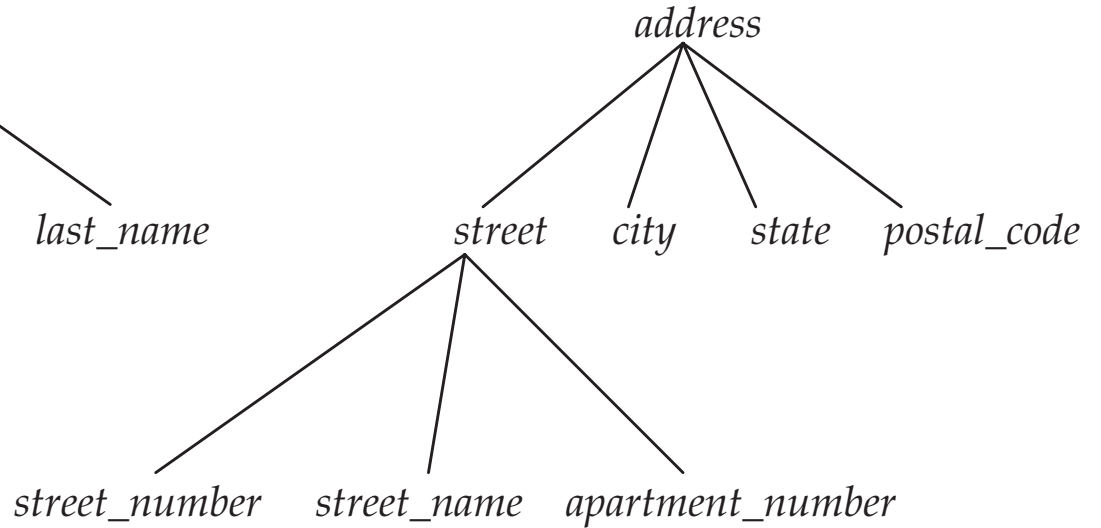



# Figure 7.05

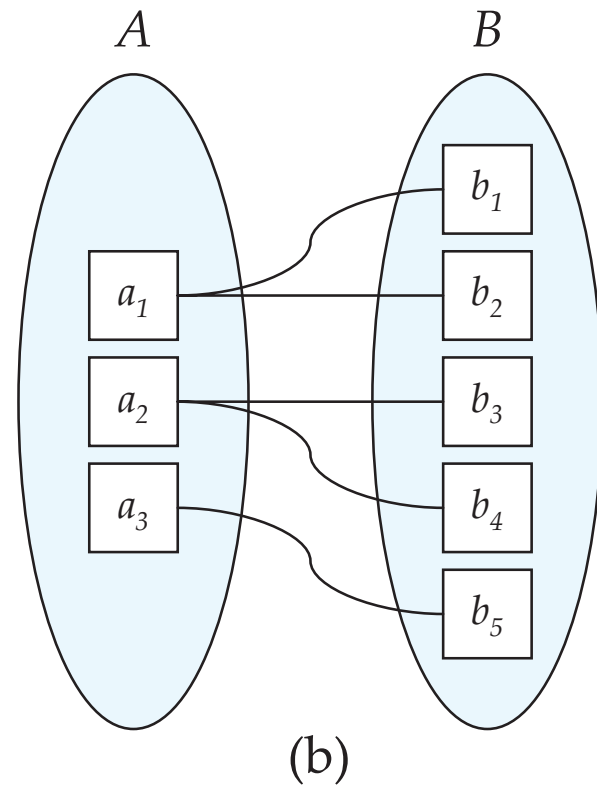
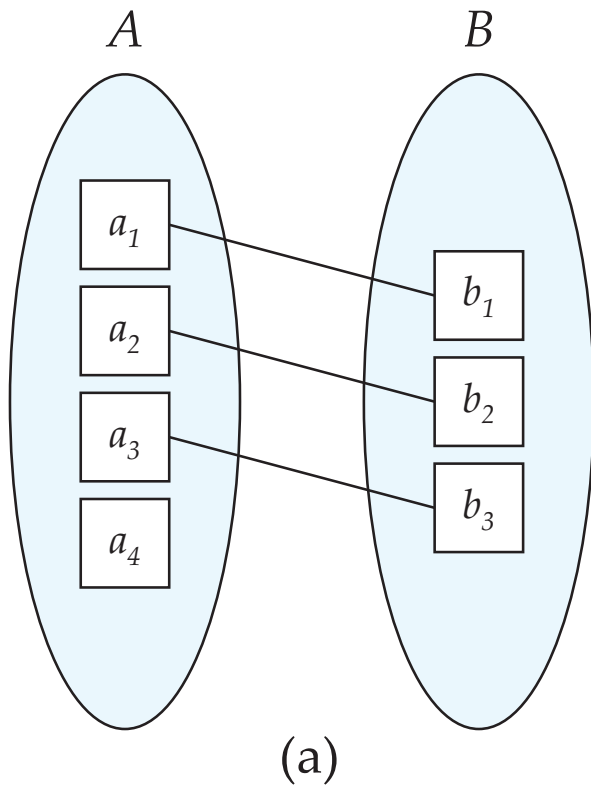



# Figure 7.06

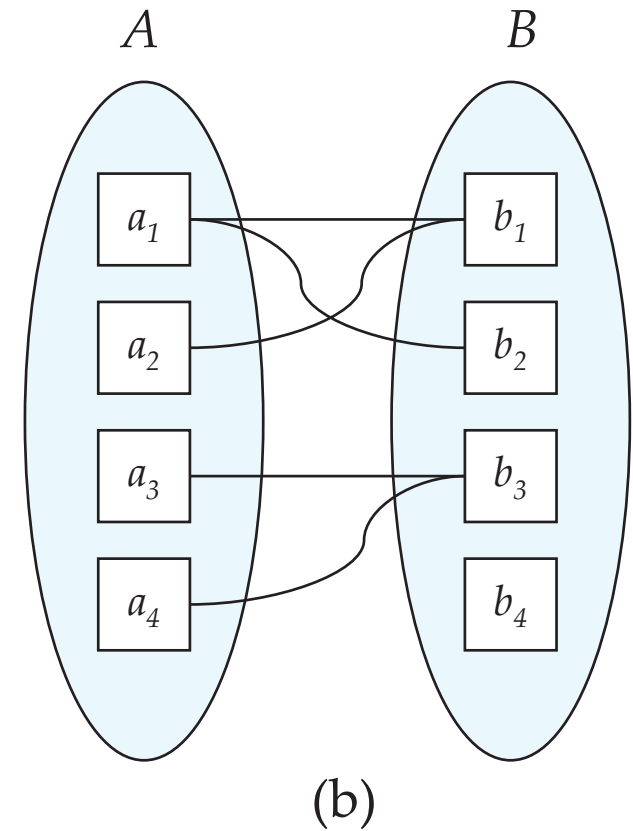
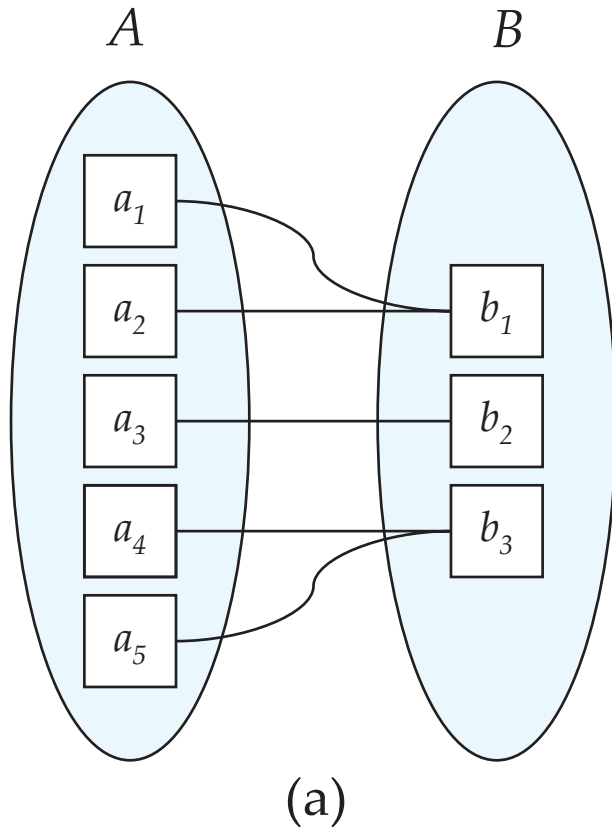



# Figure 7.07

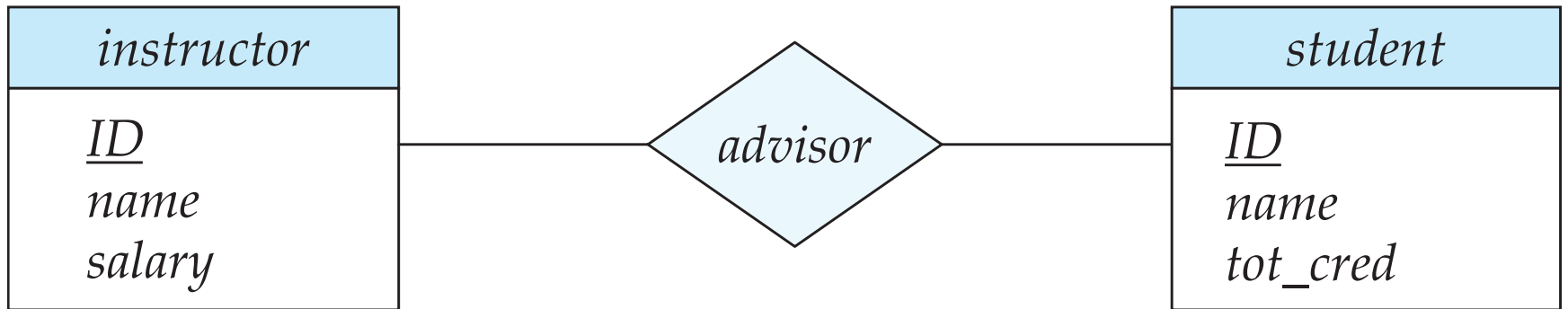



# Figure 7.08

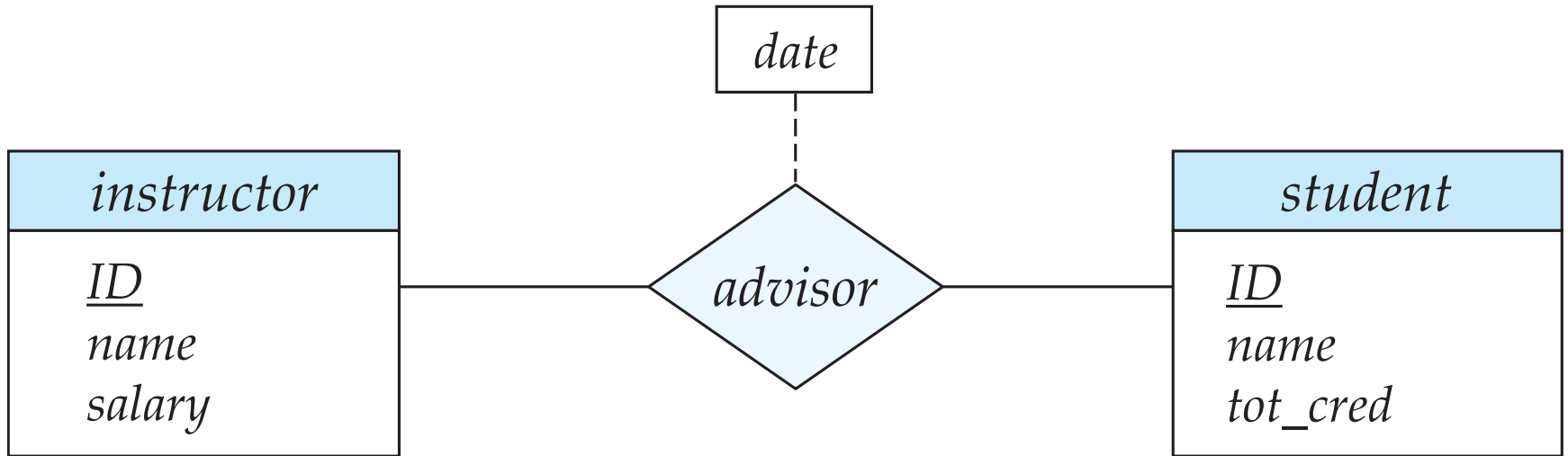





# Figure 7.09

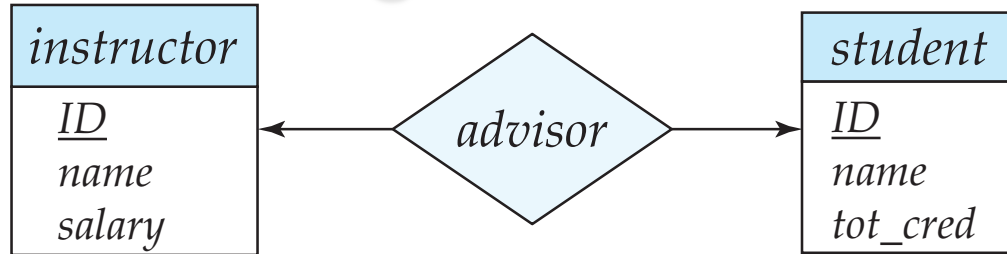

(a)

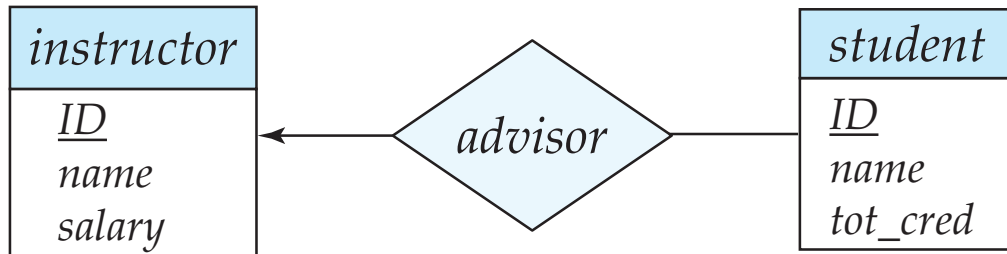

(b)

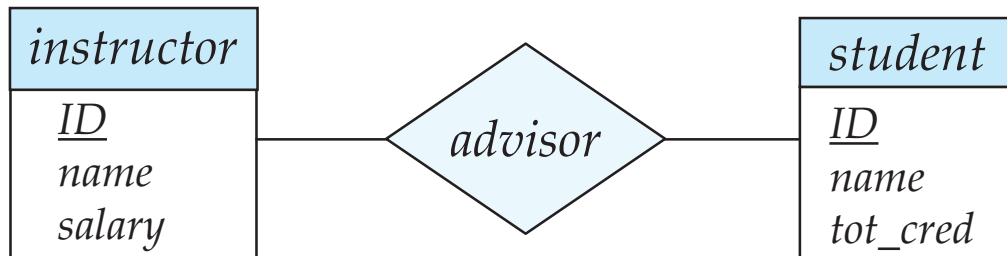

(c)



# Figure 7.10

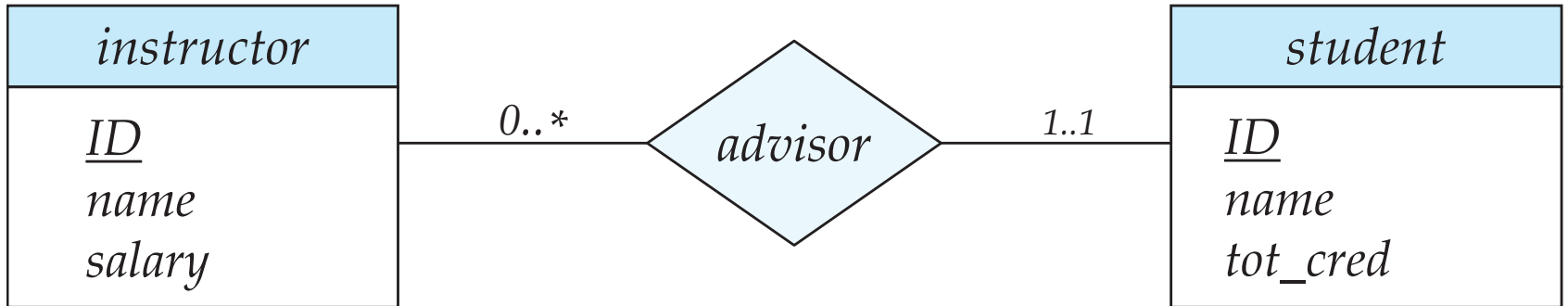



# Figure 7.11

<i>instructor</i>
<u><i>ID</i></u>
<i>name</i>
<i>first_name</i>
<i>middle_initial</i>
<i>last_name</i>
<i>address</i>
<i>street</i>
<i>street_number</i>
<i>street_name</i>
<i>apt_number</i>
<i>city</i>
<i>state</i>
<i>zip</i>
{ <i>phone_number</i> }
<i>date_of_birth</i>
<i>age</i> ( )



## Figure 7.12

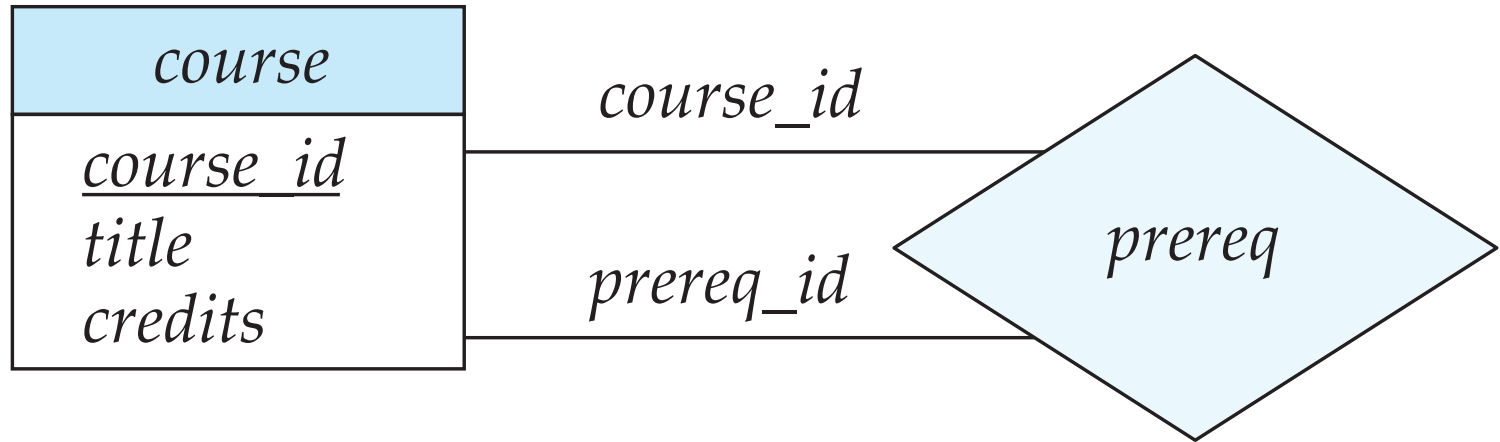



# Figure 7.13

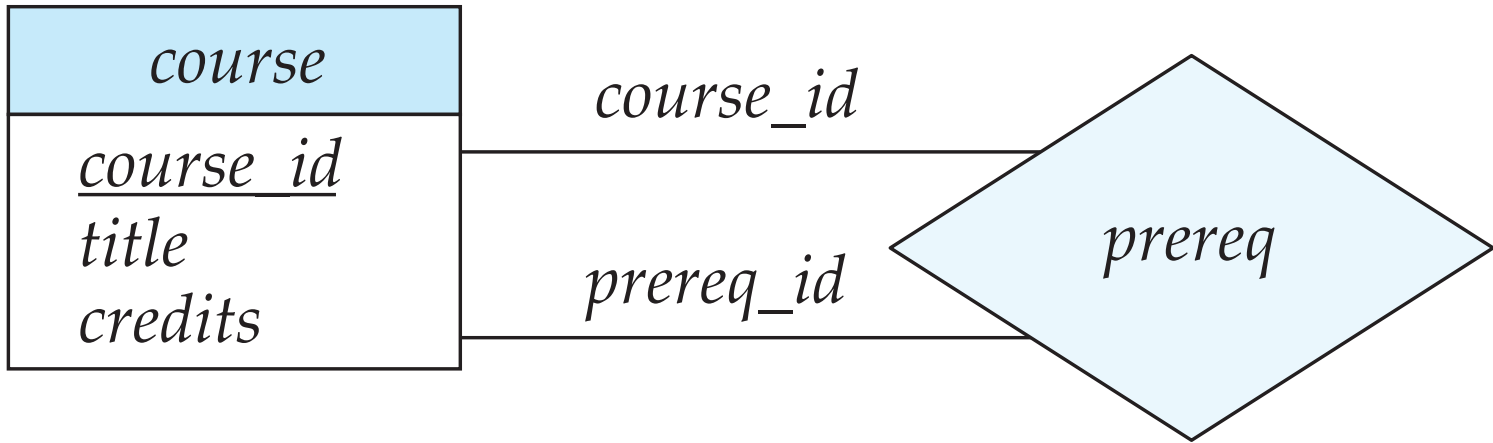



# Figure 7.14

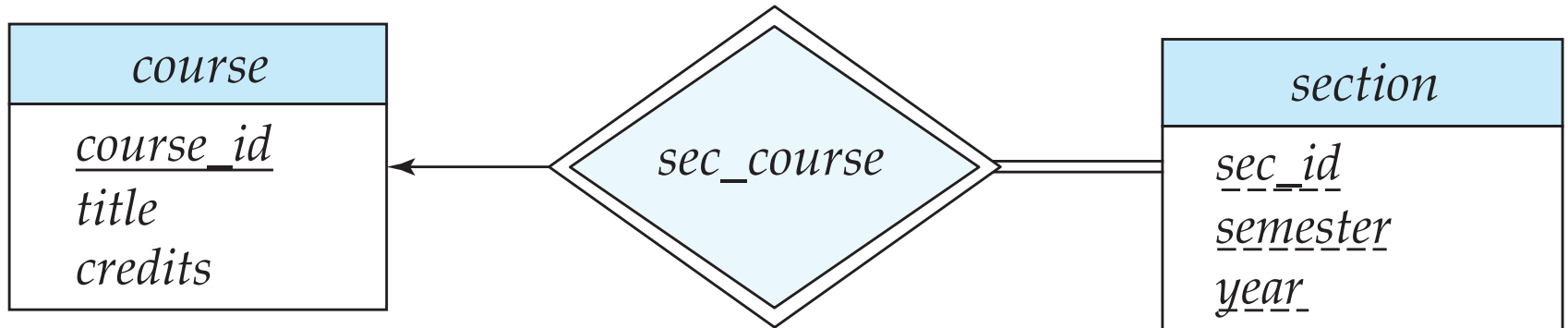



# Figure 7.15

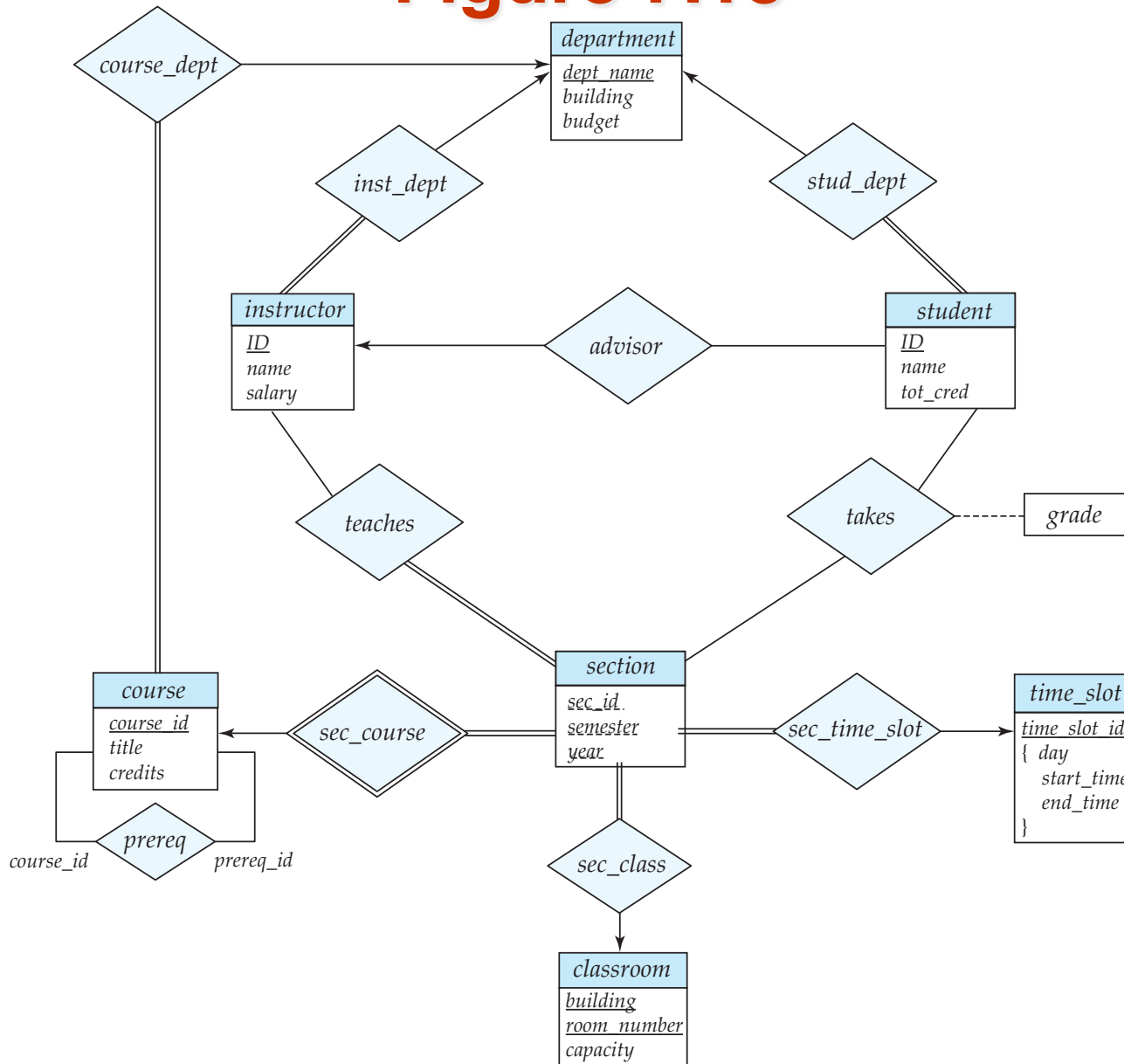



# Figure 7.17

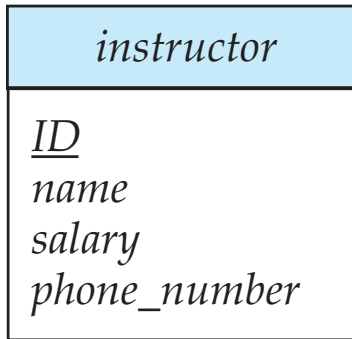

(a)

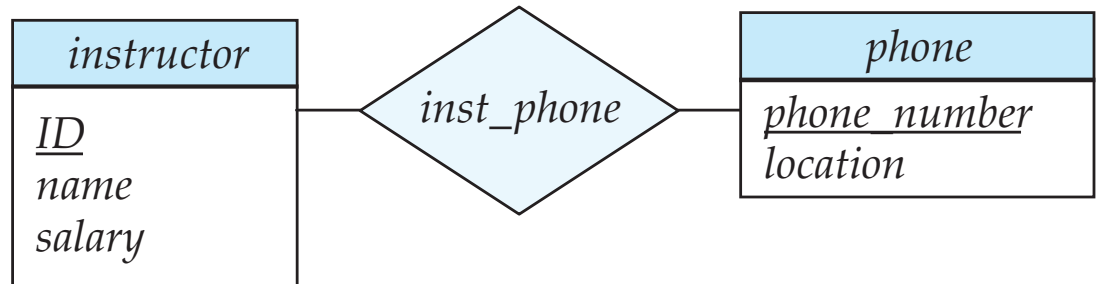

(b)





# Figure 7.18

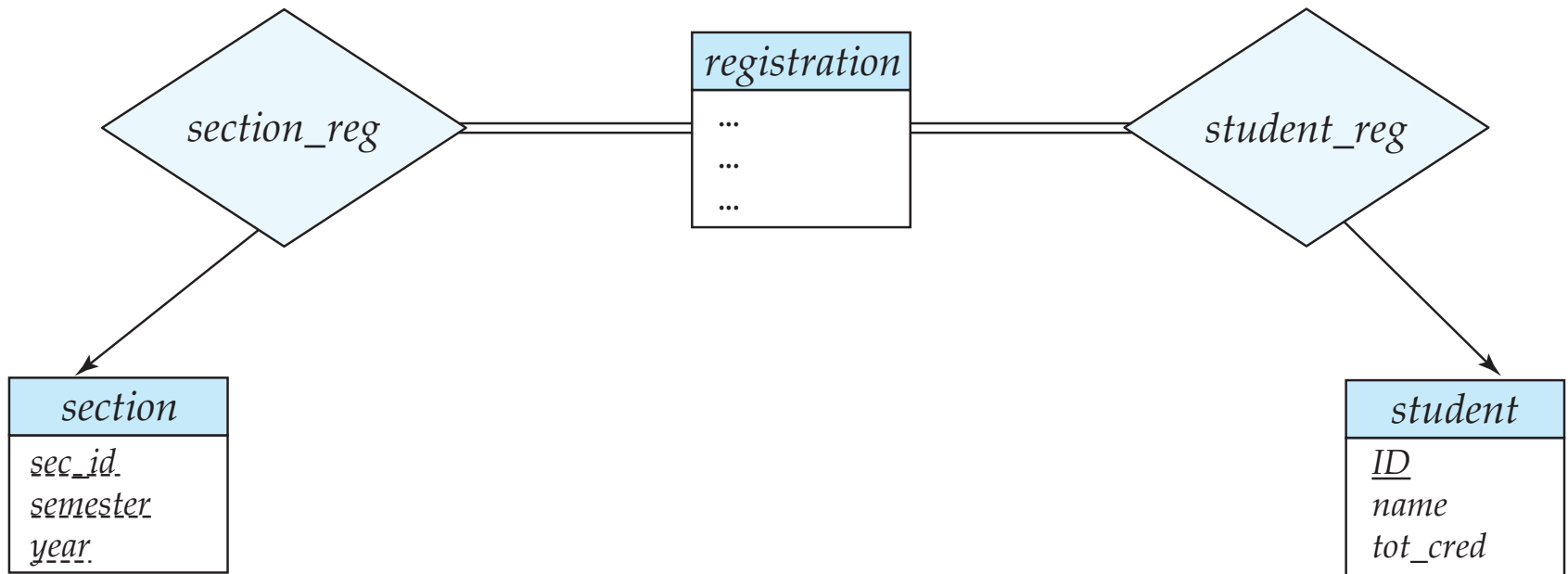



# Figure 7.19

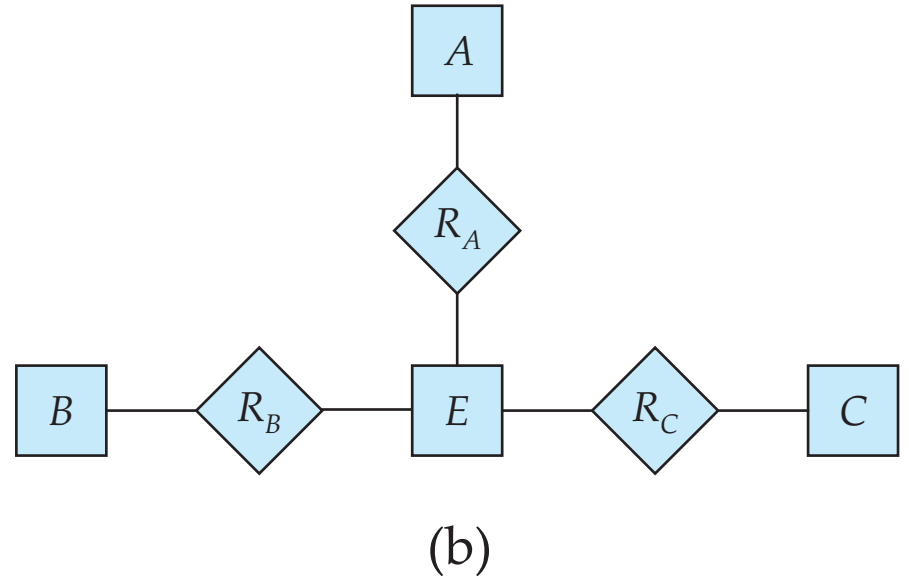
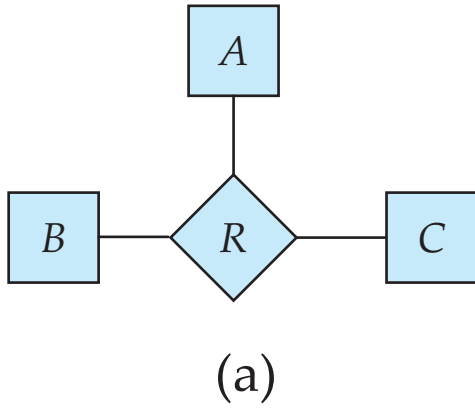



# Figure 7.20

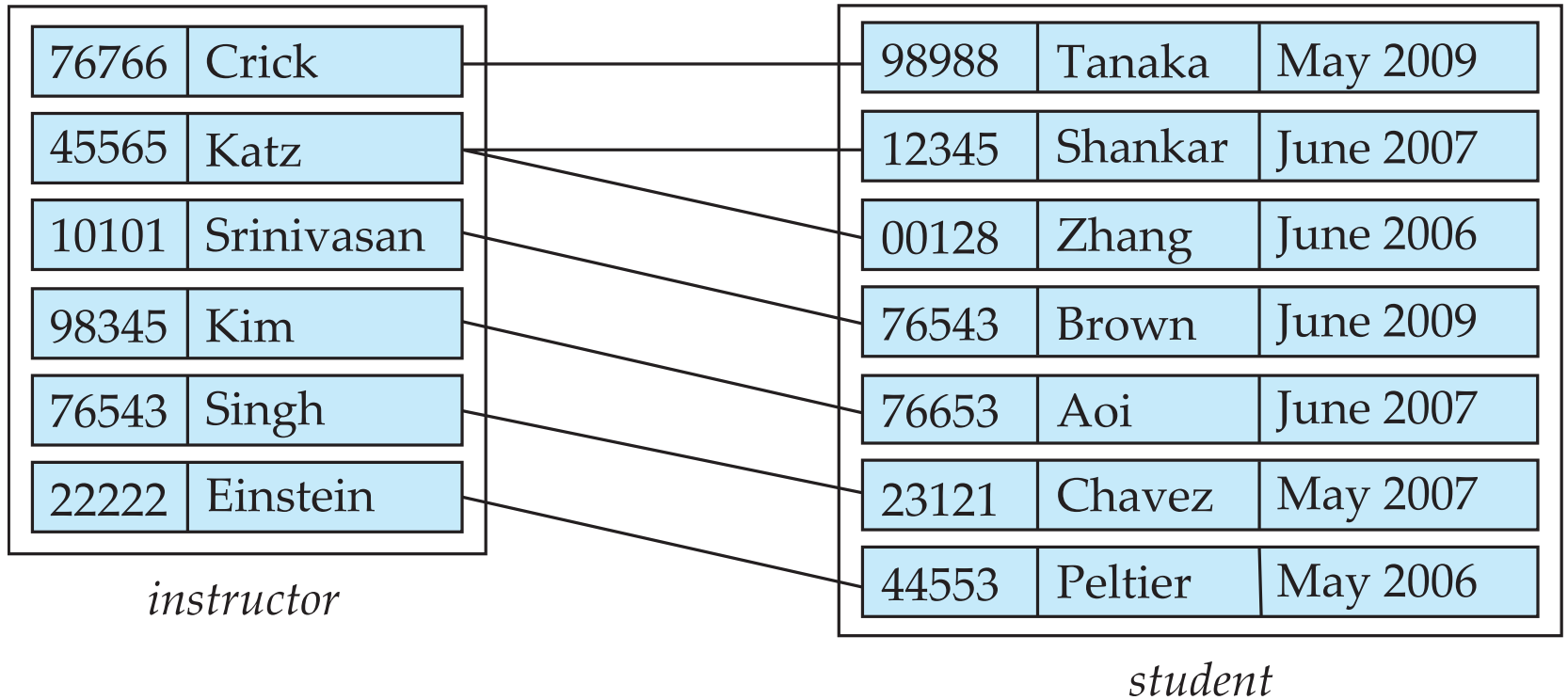



# Figure 7.21

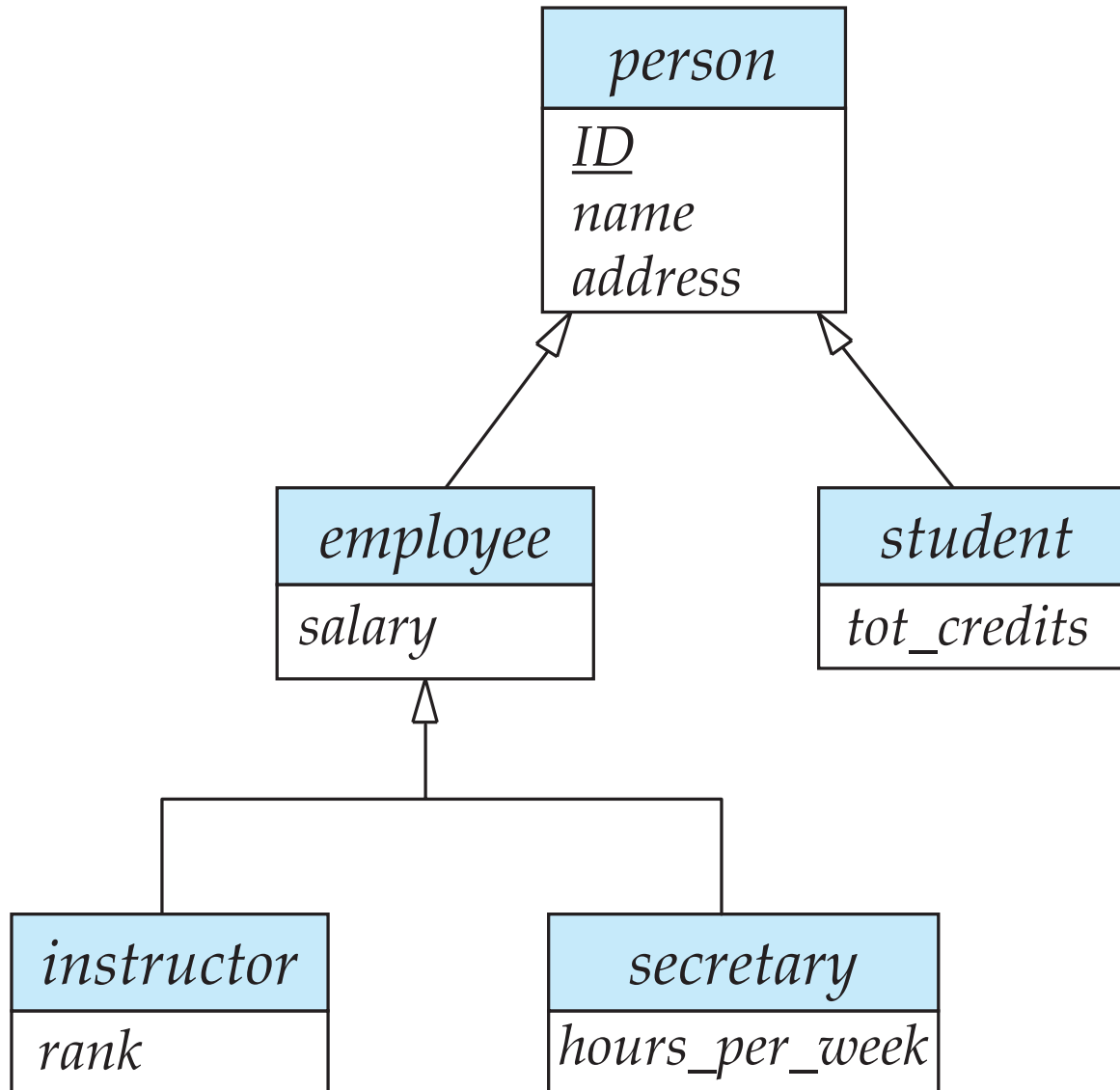



# Figure 7.22

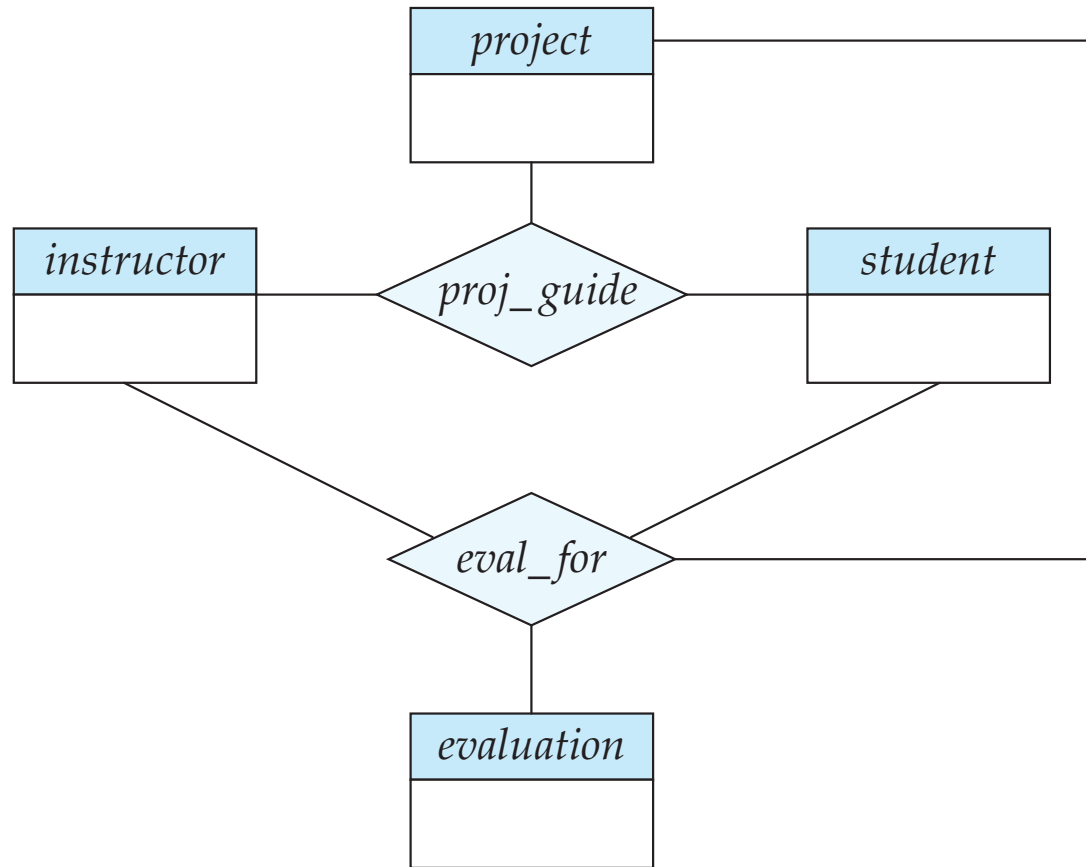



# Figure 7.23

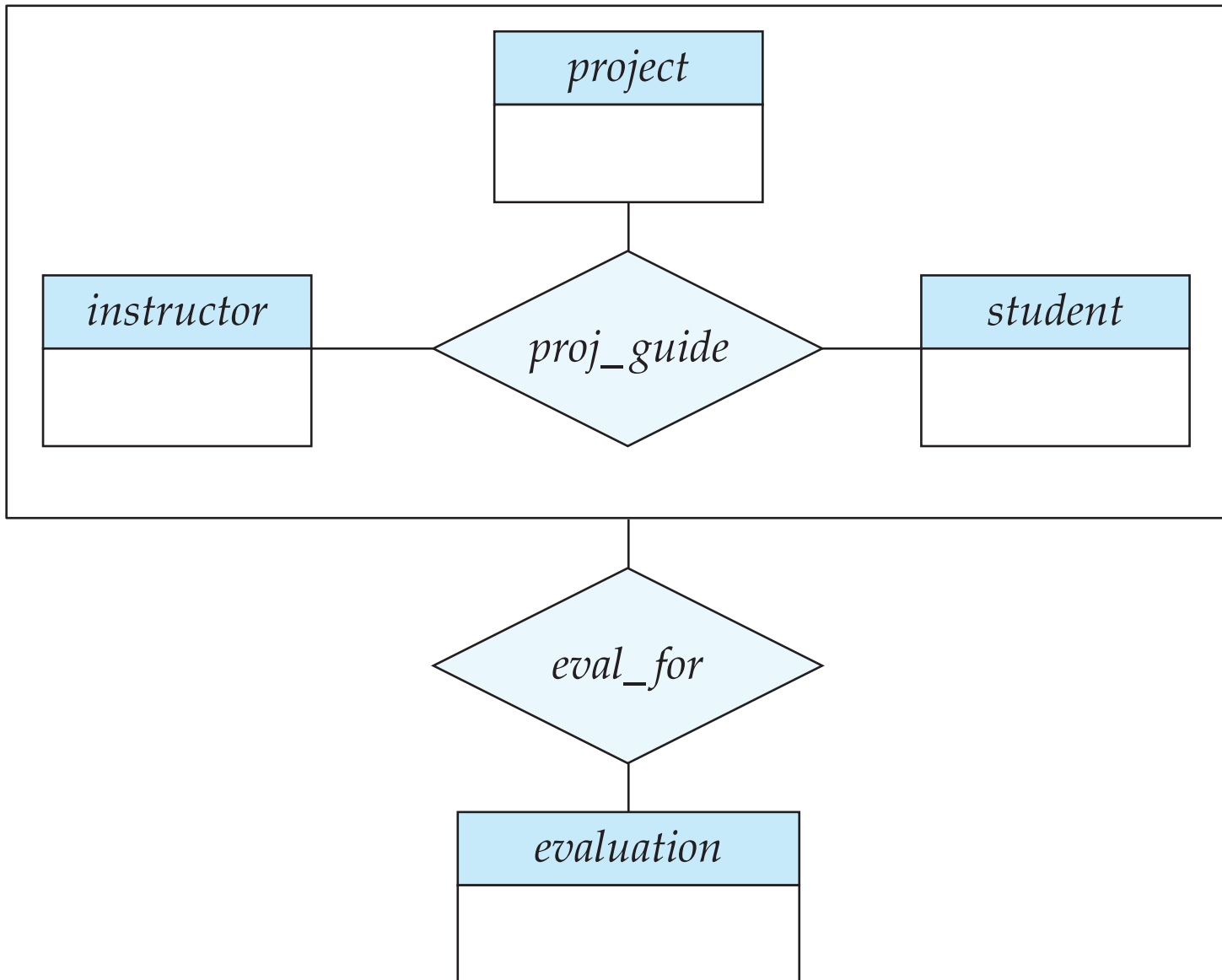



# Figure 7.24

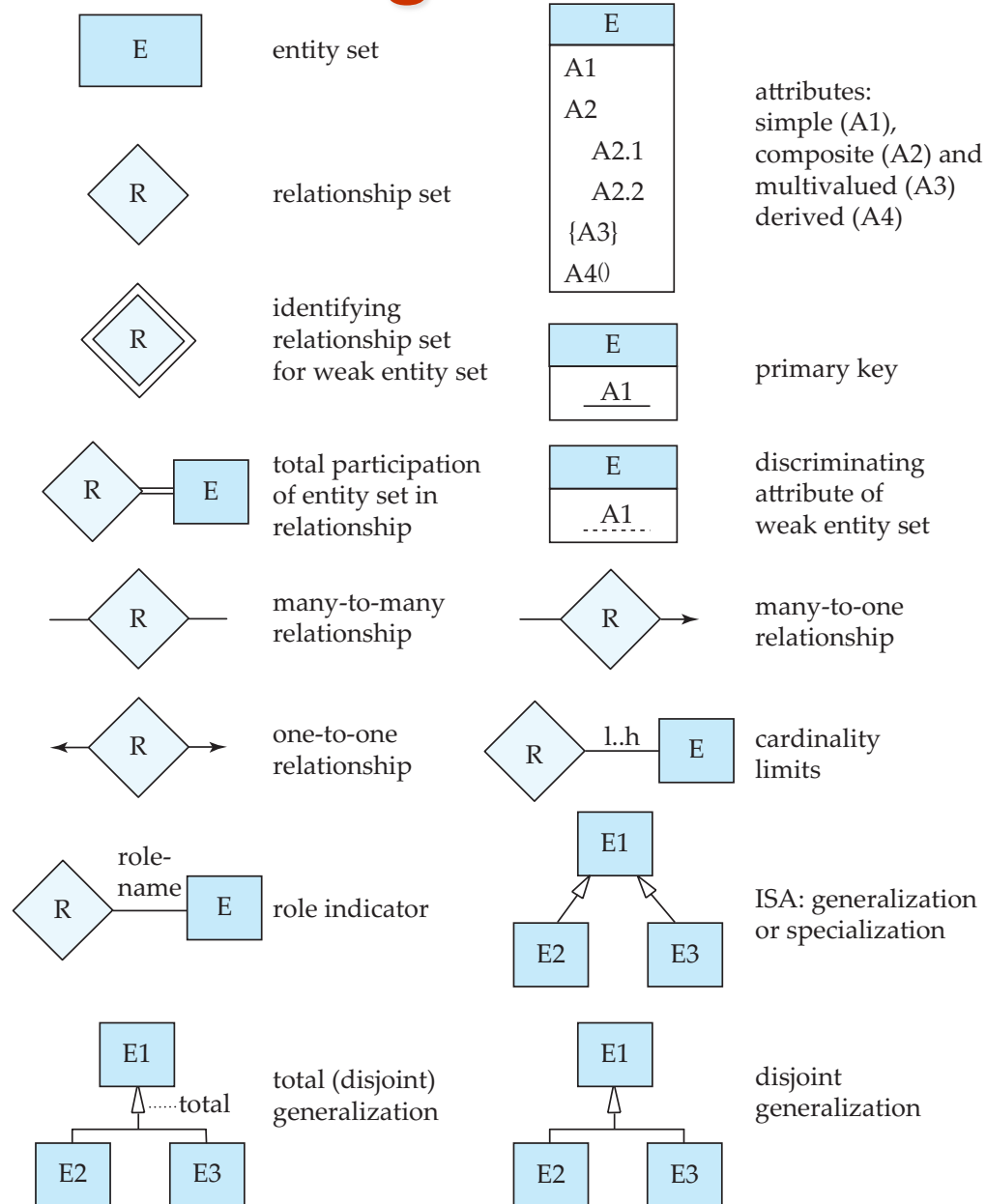



# Figure 7.25

entity set E with  
 simple attribute A1,  
 composite attribute A2,  
 multivalued attribute A3,  
 derived attribute A4,  
 and primary key A1

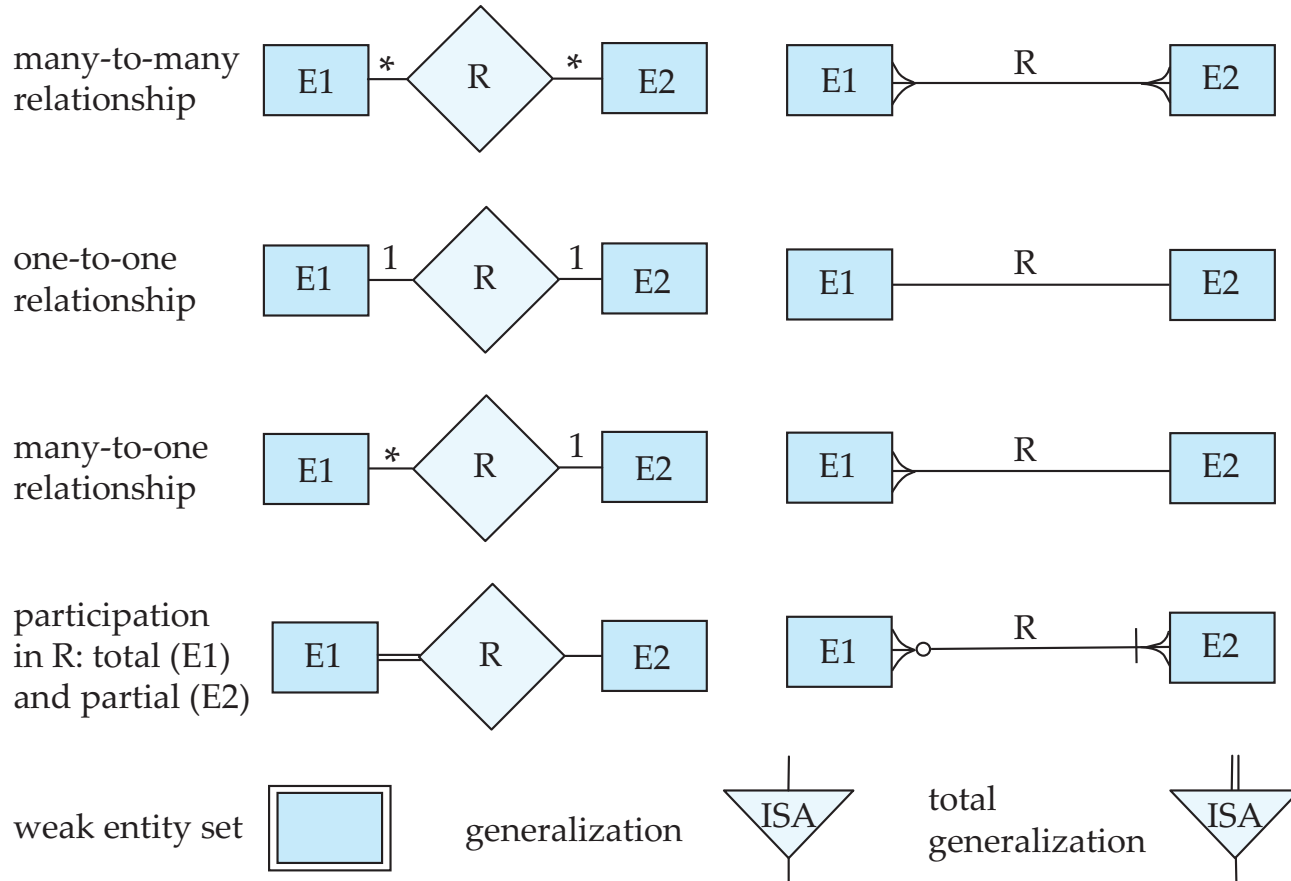
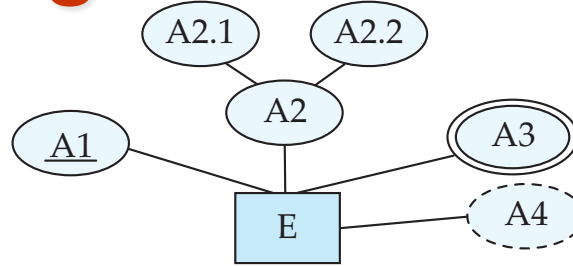





# Figure 7.26

## ER Diagram Notation

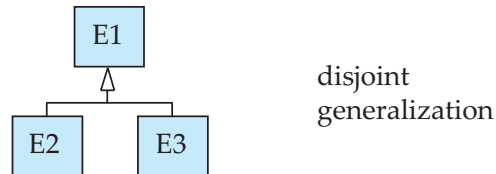
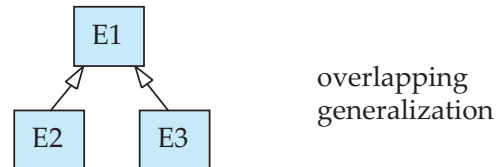
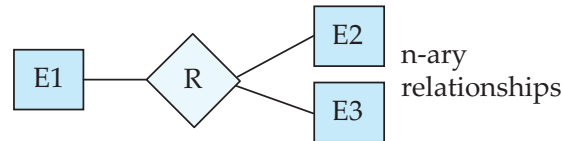
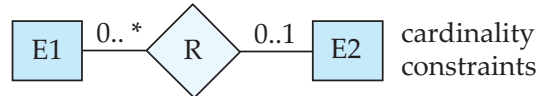
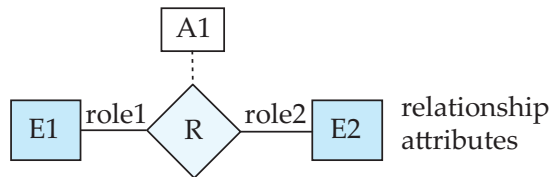
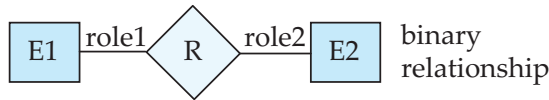
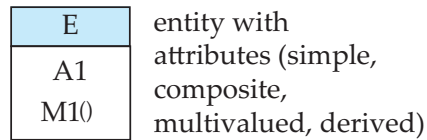

## Equivalent in UML

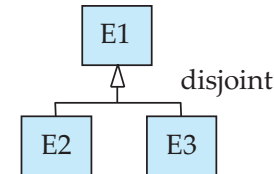
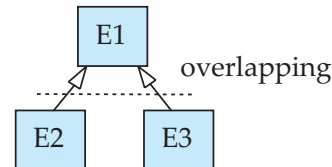
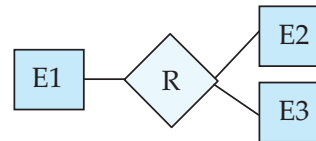
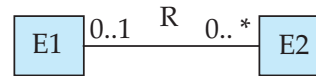
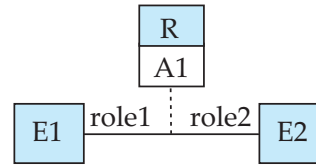
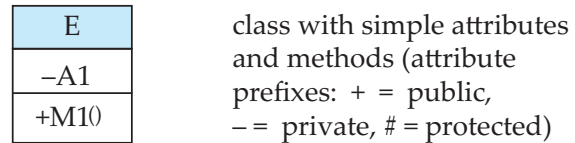



# Figure 7.27

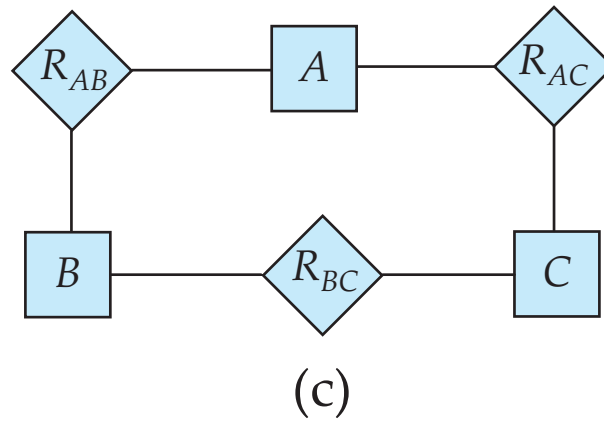
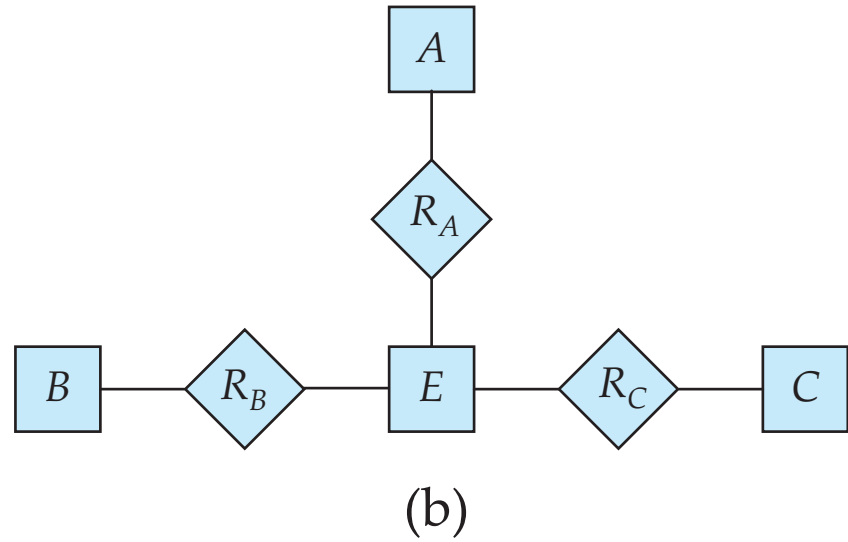
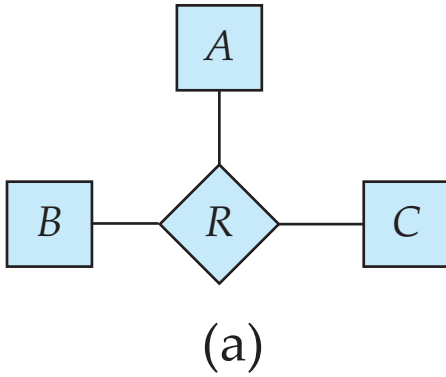



# Figure 7.28

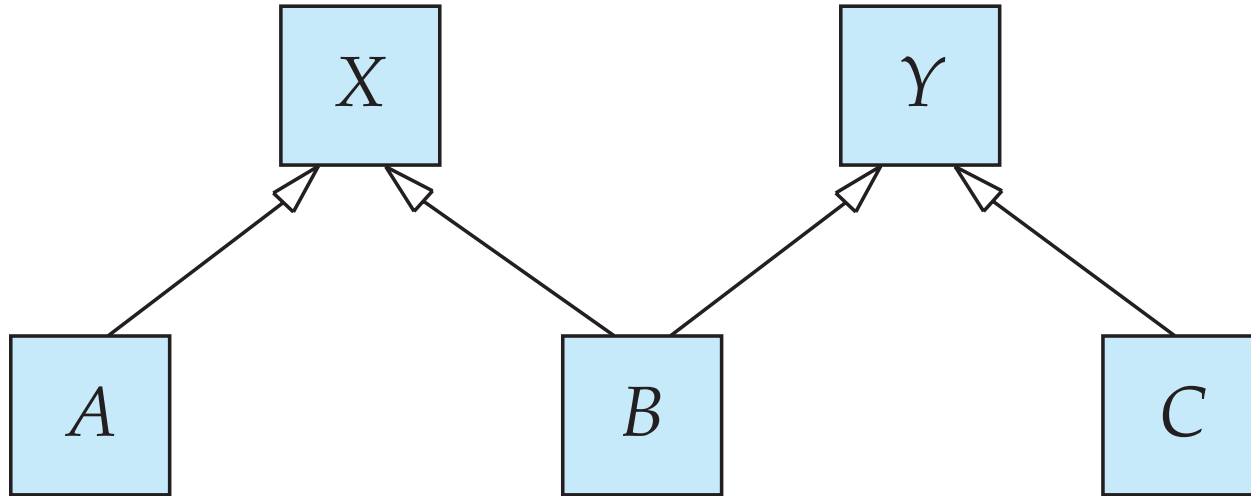



# Figure 7.29

