

Modeling Emergent Border-Crossing Behaviors during Pandemics

Eunice E. Santos^a, Eugene Santos Jr.^b, John Korah^a, Jeremy E. Thompson^b, Qi Gu^b, Keum Joo Kim^b, Deqing Li^b, Jacob Russell^b, Suresh Subramanian^c, Yuxi Zhang^b and Yan Zhao^b

^aInstitute of Defense & Security, University of Texas at El Paso; ^bThayer School of Engineering, Dartmouth College; ^cDepartment of Computer Science, University of Texas at El Paso

ABSTRACT

Modeling real-world scenarios is a challenge for traditional social science researchers, as it is often hard to capture the intricacies and dynamisms of real-world situations without making simplistic assumptions. This imposes severe limitations on the capabilities of such models and frameworks. Complex population dynamics during natural disasters such as pandemics is an area where computational social science can provide useful insights and explanations. In this paper, we employ a novel intent-driven modeling paradigm for such real-world scenarios by causally mapping beliefs, goals, and actions of individuals and groups to overall behavior using a probabilistic representation called Bayesian Knowledge Bases (BKBs). To validate our framework we examine emergent behavior occurring near a national border during pandemics, specifically the 2009 H1N1 pandemic in Mexico. The novelty of the work in this paper lies in representing the dynamism at multiple scales by including both coarse-grained (events at the national level) and fine-grained (events at two separate border locations) information. This is especially useful for analysts in disaster management and first responder organizations who need to be able to understand both macro-level behavior and changes in the immediate vicinity, to help with planning, prevention, and mitigation. We demonstrate the capabilities of our framework in uncovering previously hidden connections and explanations by comparing independent models of the border locations with their fused model to identify emergent behaviors not found in either independent location models nor in a simple linear combination of those models.

Keywords: social science, intent-driven modeling, population dynamics, pandemics, Bayesian Knowledge Bases, H1N1, disaster management, emergent behaviors

1. INTRODUCTION

Complex system theory has introduced a paradigm shift in the modeling and analysis of various natural and social systems. This shift from the prevalent reductionist thought has helped in the development of models with better fidelity. According to Magee¹, a complex system may be defined as: “a system with numerous components and interconnections, interactions or interdependence that are difficult to describe, understand, predict, manage, design, and/or change.” Miller and Page make a useful distinction between merely *complicated* systems and *complex* systems^{2, p. 9}. Complicated systems can have numerous moving parts, traits and characteristics, all of which complicate analysis, but they have one trait that is invaluable to aiding their study: they are reducible. Complicated systems can be taken apart and examined component by component, and then reassembled to understand the whole. Complex systems resist this reductionist approach, and the components within, when considered separately, do not sum to the overall functionality observed with the whole. Their overall characteristic, function, or behavior may be considered as a form of *emergence*—as Miller and Page put it, emergence exists when “individual, localized behavior aggregates into global behavior that is, in some sense, disconnected from its origins.”^{2, p. 44} Emergence especially complicates modeling efforts, as it is a challenge to understand and represent the cause and effect relationships involved.

However, it is clear that incorporating the notion of emergence is critical to modeling complex systems, particularly for complex social systems^{3, p. 5}. Natural disaster management is a specific domain where emergence is often observed and not well understood. Consider a spontaneous chain of individuals working together to fight natural disasters, such as the residents of Des Moines in Iowa stacking thousands of sandbags to deter flooding in 1993⁴ or the famous bucket brigades formed to fight fires. Sometimes these are efforts directed by a strong leader, but other times they are emergent behaviors that surface mysteriously out of need. The challenge is to model the social system with relevant structure and

properties so that appropriate emergent behaviors will take form at the appropriate time. Adding to the difficulty in modeling emergence is the additional challenge that emergent properties are easier to identify or detect than to explicitly model. Because of the non-reductionist nature of complex systems, modeling only macro-level system characteristics does not accurately represent emergence. On the other hand, frameworks that focus on micro-level characteristics often make simplistic assumptions and consequently do not lead to the emergence of interest. To effectively model complex social systems and dynamics, emergence must be a factor. When we couple the elusive nature of emergent properties with the difficulties involved with modeling complex social scenarios, we begin to comprehend the research challenges of this problem domain. Social systems are particularly challenging to model because even simple social scenarios involving multiple actors and events usually contain a very large collection of information, some relevant to successfully modeling the situation, and some not. Moreover, the relevant background and contextual specifications of the actors is usually incomplete. Social scenarios will also involve uncertain information, which increases the difficulty of modeling. Clearly, any model attempting to analyze real world social situations must be able to handle the accompanying uncertain and incomplete information found in such scenarios.

In our efforts to incorporate emergence in computational social science models and apply them to the disaster management domain, we have employed an intent model which represents actors' intentions by modeling their beliefs, goals, and actions using the probabilistic representation and reasoning capabilities of Bayesian knowledge bases (BKBs). By modeling actor intentions, we are able to build a comprehensive model of an actor's likely course of action based on interactions with other actors and unfolding events. Actors within our model can be single individuals, groups of people, or governmental, corporate, or other non-governmental organizations. BKBs are particularly effective for modeling actor intentions because they can handle uncertainty and incompleteness⁵. Knowledge of scenario intricacies is usually incomplete and uncertain, even for thoroughly explored historical situations, not to mention currently unfolding events. In this paper, we employ the intent model to analyze the emergent migratory behaviors of populations in a disaster management scenario. In particular, we model the intentions of the Mexican populace to analyze the motivations and factors affecting their decisions during the H1N1 pandemic of 2009. This is built on our previous work on the 2009 H1N1 pandemic⁶. The Mexican, U.S. and other governments, international organizations, and local governmental and private groups can all affect the actions and reactions of populations confronted with a pandemic. Compounding the chaotic dynamics of a pandemic is the existence of a national border, with the possibility of a safe haven just on the other side. All of these factors contribute to an exceedingly complex situation, with the population trying to make decisions that would keep themselves and their families safe, and numerous other international, national, and private groups trying to anticipate those actions in order to best prepare for contingencies. As we modeled this scenario, we also recognized that, due to the non-linear interactions of actors within this complex social system, there could very well be behaviors that modelers and analysts might not anticipate, which motivates the need for detecting emergent behavior. Upon further investigation, we found that behaviors we had not anticipated in our model were actually evident due to the new inferences created during BKB fusion. Owing to the dynamic nature of BKB fusion and the representational and modeling capabilities of the intent models, our modeling framework provides a suitable platform for emergent behaviors that can be substantially beneficial to scenario analysis, yet elusive to traditional modeling.

In the next section, we briefly review the evolution of emergence as a concept for study, and then explain the use of BKBs and related algorithms for successfully employing them in our intent model in the following section. In Section 4, we describe our approach to identifying the occurrence of emergence within our model, and then explain our experimental setup and results in Section 5. Conclusions follow in Section 6.

2. EMERGENCE BACKGROUND

In order to establish the groundwork for later discussions, we shall first provide some background information on emergence and the current state of the art in modeling emergence. The core concept at the heart of emergent behavior was identified as early as 350 B.C. by Aristotle when he noted "...the totality is not, as it were, a mere heap, but the whole is something beside the parts..."⁷. In essence, Aristotle was noting that complex systems, in particular life forms, amount to more than what all the individual pieces produce separately. With the study of complex systems beginning in the 1960s⁸⁻¹¹, the foundation was laid for the importance of emergence as a concept. Emergence has been addressed in a number of widely different scientific fields. Hexmoor, et al.¹² proposed an architecture intelligent agent, and presented the principles used for building GLAIR (Grounded Layered Architecture with Integrated Reasoning). The authors distinguished three levels of behavior control and generation, namely Knowledge Level, Perceptuo-Motor Level, and Sensori-Actuator Level. They then investigated computational and representational power regarding response time and

control complexity. In the model, a computer agent chooses physical actions that are preprogrammed for the robot. In addition, the agent was instructed to perform higher-level tasks and, in the midst of accomplishing those tasks, expected to have behaviors emerge. An example of an emergent behavior in the study is "moving toward an object" that is learned and consequently used in the agent's repertoire of actions. While we can certainly see the emergent component to this research, it is focused purely on individual behaviors and not on social behavior. In contrast, Mataric¹³ characterizes emergent behavior as not explicitly programmed in, but resulting from local interactions among components. In particular, the study focused on how a specific type of emergent collective behavior can be driven by simple local interactions. She describes a synthetic approach to designing and testing a variety of social interactions and cultural scenarios, and validates it through an autonomous robot simulation. Basic interactions addressed in the paper were: collision avoidance; following; dispersion; aggregation; homing; and flocking. Mataric manages to address emergence in a fundamentally social setting; the emergence is centered around instinctive, natural behaviors of less-than-human social creatures. The bigger challenge is to capture emergent behavior in complex human societies. These efforts go a long way towards advancing insight into emergence as a concept, but leave much to be explored regarding human social emergence.

Emergence has become a critical component to the analysis of complex systems in numerous areas of scientific study. Bar-yam¹⁴ defines emergent properties as system properties that do not reside in any subsystem, but rather in the whole system. Meaningful definitions of strong emergent properties and multi-scale formalism were presented. Strong emergence follows an ensemble perspective, in which physical systems are only meaningful as ensembles rather than individual states. For example, a string of bits including a parity bit was mentioned since it has a property that would be found in observations of the state of the system as a whole. In addition, regarding emergence of collective behaviors, a collective constraint can be caused when the environment interacts with the system. The mathematical characterization presented in the paper captures the multi-scale variety of subsystems. Strong emergent properties result in oscillations of multi-scale variety with negative values. Social systems, including various allocation, optimization, and functional requirements on the behavior of a system, can be examples of collective constraints. Bar-yam greatly furthered understanding of emergent properties within complex systems, establishing a useful foundation for further discovery and application to a wide-range of complex systems, including the social systems of interest here.

Finally, emergence has become an interest in the study of disaster management. Provitolo and Dubos-paillard⁴ propose a typology of behaviors observed during catastrophes, and identify the common properties for those behaviors. They framed emergent behaviors with respect to a time continuum defined by pre-catastrophe, catastrophe and post-catastrophe phases. They also proposed how emergent behaviors can either be transformed to another type of emergent behavior, transformed to a non-emergent behavior, or simply vanish. The behaviors in catastrophic situations, which were represented as a function of the cognitive factors and of the adaptive capacity of individuals, were identified as emerged. They also categorized emergent human behaviors into four different classes depending on their social feedback and influence for integrating interdisciplinary approaches of scientific communities. The authors' efforts in this area apply directly to social emergence, and establish a framework for defining categories of emergent behavior specific to disaster situations. The authors do not, however, attempt to model those situations, nor predict what behaviors might emerge. The work by Casper, et al.¹⁵ focuses on identifying circumstances where emergent behavior is desired for managing disasters, and how organizational leadership contributes to enhance disaster response and recovery operations. Eight different incidents were analyzed for identifying leadership themes. Five themes impacting self-organizing behavior were identified. By developing the capacity for self-organization, and promoting an organizational culture, emergency management officials can lead responses to complex incidents more effectively. While this is certainly an interesting study in the individual behaviors of leaders during crisis, it provides little insight into the complex behaviors of the multitudes of actors in a disaster scenario.

Intent modeling, on the other hand, offers the ability to address complex social systems. The most difficult aspects of complex social systems center on uncertainty, incompleteness, and emergence. It has been previously demonstrated that BKBs and intent modeling provide unique competencies for handling uncertainty and incompleteness in various scenarios¹⁶⁻²¹. The most exciting breakthrough of recent import concerns the ability of BKB fusion to yield unexpected and unplanned behaviors through the interaction of disparate influences within a scenario. Moreover, the intent modeling framework provides the capability to represent various social, political and economic (which are considered to part of culture in our methodology) factors that are relevant to the actors and behaviors being modeled. This is the crux of the research discovery being reported here.

3. INTENT FRAMEWORK

To examine emergent behavior, modeling the behaviors of actors within the scenario is an elementary step to take. To find emergent behaviors, we must first have actors that react to events within the scenario. To this end, an intent model⁶ is employed to represent the likely actions of those actors. The intent model makes use of a probabilistic representation called Bayesian knowledge bases (BKBs), where knowledge pieces are encoded through special graphs with nodes tagged either with the knowledge of interest, or with probabilities associated with that knowledge. Multi-scale modeling is accomplished both through explicitly modeling distinctly different scales of information, and through fusing local micro-scale BKB fragments to form a regional intermediate-scale. In the similar manner, regional scales models may in turn be used to generate macro-scale state or national models. To complete the necessary foundation for the intent model, we next provide the fundamental theory of BKBs, as well as the algorithms we use to integrate multiple BKB fragments while at the same time maintaining probabilistic soundness. Finally, we present the framework of intent-driven modeling, in which individual intent is inferred from computational reasoning through BKBs.

3.1 Bayesian Knowledge Bases (BKBs)

The knowledge used by individuals in their decision making, along with other aspects of their behavior, can be represented by BKBs, which are represented by directed graphs with correlated context. BKBs are an alternative representation to Bayesian networks (BNs). BKBs and BNs are similar in that they both are probabilistic models adept at computing likelihoods for uncertain information; BKBs differ from BNs in their ability to allow incompleteness and cycles in their context-specific information. Graphs representing BKBs are composed of two types of nodes: one type (support node or S-node) represents probabilistic information, while the other (instantiation node or I-node) denotes the context relevant to the probabilistic relationship. Arcs denote causal relationships between two connected nodes¹⁸. For example, the simple information regarding “if I believe local border control becomes strict, I would consider crossing the border illegally” can be represented by a couple of I-nodes including “Local border control becomes strict” and “Cross border illegally” and S-nodes as shown in Figure 1. Note that I-nodes represent possible instantiations of random variables (RVs), and thus an I-node equates to a single RV state. Again, from Figure 1, the I-node “Cross border illegally” represents the state “illegally” of the RV “cross border.” In a similar fashion, there could be an I-node “Cross border legally” which would represent the state “legally” for the same RV “Cross border.”

BKBs are simpler and more concise than BNs, since they can maintain partial information consistently and facilitate reasoning with less complexity. Unlike BNs, BKBs are completely capable of handling incomplete probabilistic information, which is invaluable to modeling real-world situations, where not only is uncertainty prevalent, but also where complete information is absent even for well-known historical situations. As in BNs, reasoning with BKBs is based on the calculation of joint probabilities over the possible inferences. Unlike BNs, a complete probability distribution is not required in order for BKBs to compute inferences. Here, an inference is a subgraph of a BKB, including at most one I-node of each RV and the associated S-nodes. The idea of inferencing plays an important role in two forms of reasoning with BKBs, belief revision and belief updating. The goal of belief revision is to find the most probable outcome of the world that contains all the evidence¹⁸, and the goal of belief updating is to update the posterior probability of an I-node given evidence. For more information about the algorithms and their complexity, please refer to ²².

3.2 Intent modeling with BKBs

Intent can be derived by combining the actions, beliefs, and goals that are pursued by individuals. In BKBs, individual intent can be inferred from probabilistic reasoning with appropriate sets of evidence^{23,24}. We make use of the adversarial intent inferencing (AII) model of Santos and Zhao⁵ to create BKB fragments. Actor beliefs, goals, and actions are captured using the AII structure, which can also be applied to other cultural information. This information is represented using four categories:

- Axioms (X): what the actors believe about themselves.
- Beliefs (B): what the actors believe about others.
- Goals (G): what the actors hope to achieve.
- Actions (A): the actions the actors may carry out to fulfill their goals.

RVs of each of these types are defined, and each of their possible states is included as an I-node in a BKB fragment. Probabilistic relationships between the axioms, beliefs, goals, and actions are included as S-nodes in the fragment. Refer again to Figure 1 for an example of encoding intent into a fragment, specifically regarding the likelihood to cross the U.S. border illegally based on beliefs about local border control and a general desire to migrate to the U.S. Note also that the I-node names are prefaced with “(X)”, “(B)”, “(G)”, or “(A)” to indicate whether the RV represents an axiom, belief, goal, or action, respectively.

Additionally, this structure is useful to include cultural or background information about actors, which then affects their decisions. These cultural fragments are most often represented by axioms or beliefs the actor holds, as well as possible goals or actions derived from those axioms or beliefs. Earlier publications^{16,20,25} have described the methodology for incorporating various socio-cultural factors in more detail. Similarly, our intent model makes use of event fragments, which represent events occurring within the timeline of the scenario, including the actions of individuals or groups not explicitly modeled.

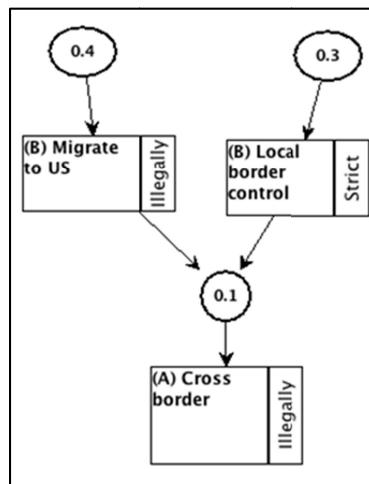

Figure 1. Example of a BKB fragment

3.3 BKB Fusion algorithm

For capturing the intricacies and dynamisms of real-world situations, handling knowledge dynamically while preserving consistency is essential. Therefore, we have developed fusion algorithms to integrate multiple BKBs and to tune the reliabilities of each source appropriately. In general, the information contained in BKBs is collected from different sources, similar to how we aggregate information provided by various experts in our daily lives. Therefore, it is natural to rely on some sources more than others in the same way that we assign higher reliabilities to information sourced by trustworthy experts. Our Bayesian knowledge fusion algorithm is designed to integrate multiple BKBs and encode the reliabilities of the sources, while maintaining probabilistic soundness throughout the fusion process. The BKB obtained from the process of fusion preserves all of the information contained in the original BKBs, while knowledge pieces remain tagged with their sources and relevant reliabilities, as described by Santos, et al.²⁶. In particular, two types of nodes are added: a source node (a special type of I-node) and its reliability index. All S-nodes in the original BKBs are tagged with these source nodes that are indexed by the source reliability. With these additional nodes, we are able to differentiate the information contained in the fused BKB based on the original trustworthiness of sources during the inference process, without violating any of the rules imposed by the original BKBs.

For example, the BKB fusion algorithm takes two BKBs for two Mexican cities on the US-Mexico border (as shown in Figure 2), where the left BKB fragment represents a personal intent for residents of Juarez to cross the US-Mexico border illegally, while the right BKB fragment describes a similar intent for residents of Nogales, and generates the fused BKB shown in Figure 3. All S-nodes in the original BKBs are now tagged with additional source nodes indicating whether the information comes from Juarez or Nogales, and reliability indices defining the trustworthiness of the sources. For this example, we weight them all equally. This algorithm helps integrate knowledge gathered from different sources for representing dynamic situations, including both national and local level information.

We have surveyed the literature of emergence in general, and defined some of the most critical tools and methods needed to advance our research, specifically looking at BKB reasoning, intent modeling, and BKB fusion. While these approaches were critical to arriving at this point in our research, the crucial discovery is related to how our intent model, and more specifically how BKB fusion, enable investigators to probe beyond the expected bounds of explicitly modeling, and delve into the most puzzling aspects of complexity theory, that of emergence. It is now time to discuss in detail how we define and detect emergence within our model.

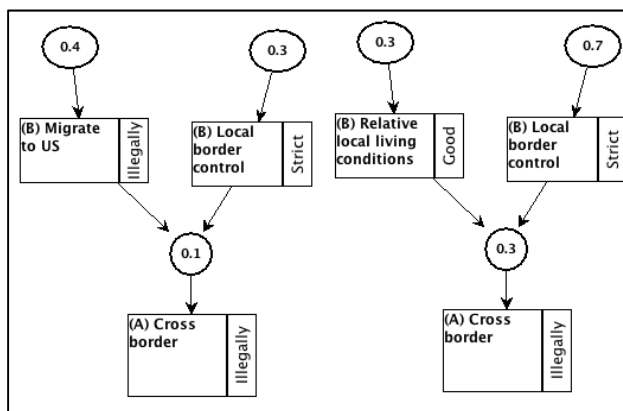

Figure 2. BKB from Juarez (left) and Nogales (right) before fusion

4. MODELING EMERGENT BEHAVIOR

While we have already discussed the concept of emergence in general, we have yet to define the notion of emergence within our own intent model. The following paragraphs provide our definition of emergence as well as the algorithm we use to automatically detect emergence.

4.1 Emergent Behavior

One of the key capabilities of the intent framework is to uncover hidden connections between independent local models by identifying emergent behaviors activated through micro-level interactions. As introduced in the previous sections, we apply BKBs to model individual knowledge, behavior, and intentions. Emergent behaviors in BKBs can be defined as new behaviors occurring when fusing individual BKBs, where such behaviors can neither be found in the independent local models nor in a simple linear combination of those models. For instance, we consider two actors that are adjacent to each other. Inferencing over their separate knowledge bases we find that both actors' most probable action is to decide not to cross the border. However, after considering their interaction through fragment fusion, the most probable collective behavior changes to choosing to cross. Such a result cannot be predicted by linearly combining their individual decisions. The reason that BKBs can be used to model such emergent behavior is that new inferences/knowledge can be generated in the process of BKB fusion. Back to the example shown in Figure 3, the dotted rectangle encloses a new inference composed partially from Juarez and partially from Nogales. From a probabilistic perspective, the emergent behavior is made apparent because the joint probability of the new inference is large enough to dominate the belief revision result, and thus change the most probable outcome in the fused model into a new state. Later we actually define this particular example of emergence as *strong* emergence, but first we define a subtler form of emergence as *weak* emergence.

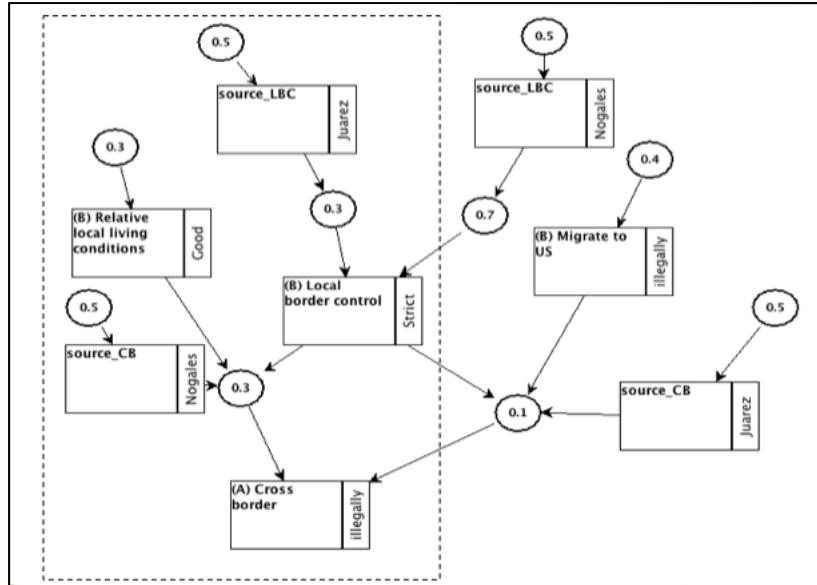

Figure 3. BKB after fusion

4.2 Identifying emergent behavior

As BKBs support a mathematically sound reasoning system that not only indicates the most likely outcomes given the evidence, but also calculates the marginal probability for each of the outcomes, we developed an algorithm based on the BKB framework to automatically identify emergent behaviors. In the process of defining emergence for our model, we found that our algorithm could detect a subtle type of emergence which is not readily observable without the assistance of computation. This *weak* emergence is valuable because it scopes the range of behaviors where a stronger, more visible form of emergence might exist.

4.2.1 Weak emergence

Using the BKB's definition¹⁸, we can now formalize the emergent behavior modeled by BKBs. Given two BKB fragments K_1 and K_2 , and two evidence sets e_1 and e_2 , let $P_1(X = x|e_1)$ and $P_2(X = x|e_2)$ be the probabilities of the target outcome $\{X=x\}$ reasoned from K_1 and K_2 respectively. Without loss of generality, we assume $P_1(X = x|e_1) \leq P_2(X = x|e_2)$. Also, let $p'(X = x|e_2, e_2)$ be the probability of $\{X = x\}$ reasoned from a new BKB K' where K' is the fusion of K_1 and K_2 .

Definition 1: An emergent behavior is identified if $p'(X = x|e_2, e_2) \notin [P_1(X = x|e_1), P_2(X = x|e_2)]$.

The intuition behind this definition is derived from the fact that emergent behavior is a consequence of non-linear interactions between constituents within a social system. Therefore, within our methodology, emergence is said to occur when the probability of the target outcome in the fused BKB is not a linear weighted sum of p_1 and p_2 (We assume the weights/reliabilities of all actors are between 0 and 1). For example, if the probabilities of "Cross border = No" from actor 1 and actor 2 are 0.4 and 0.5 respectively, then after fusing two actors together, we can calculate a new probability from the fused fragment. From the emergent behavior definition, a new probability of 0.37 will indicate that an emergent behavior happens as 0.37 is not within the range of [0.4, 0.5]. The proof that no new, emergent behaviors will fall within these bounds follows:

PROOF

Given: Two BKBs K_1 & K_2 , let t_1, t_2 and t' be the inference graph sets of K_1, K_2 and the fused BKB K' respectively. If there are no new inference graphs resulting from the fusing, where a new inference is defined as an inference in t' consisting of paths from both K_1 and K_2 , then there is no weak emergence. In other words, there is no weak emergence if t' is simply a union of the

inferences from t_1 and t_2 separately.

Proof: Apparently, if the upper condition is satisfied, then for any inference s_1 in t_1 and s_2 in t_2 , the only common I-node that s_1 and s_2 could possibly share is the very bottom I-node x (i.e. x has no descendent S-nodes). Otherwise, let x' be another common I-node, then there will be a new inference in t' where the path from x' to x is from s_1 and the rest is from s_2 , contradiction.

Case 1: Only one BKB has the target I-node x . Assume x appears in K_2 . Then t' equals to t_2 except for the source nodes. The marginal probability of x in K' is the probability sum of the inferences containing x , where the probability of each inference is just the product of the S-nodes in K_2 times the product of the source node reliabilities for each RV. As the reliability of any source node is in the range $[0,1]$, it follows that

$$0 = p_1(x) \leq p'(x) \leq p_2(x)$$

Case 2: Both K_1 and K_2 have the target I-node x . From observation, x is the bottom I-node in K' . As all I-nodes but the bottom I-nodes have only one source indicator. For any variable v whose instantiations are not the bottom I-nodes, the reliability of its corresponding source node equals to 1. Let $pa_k^i(x)$ be the probability of k_{th} parent of x in BKB i ; $p_i(x|pa_k^i(x))$ be the probability of x conditional on its k_{th} parent in BKB i . From Bayes theorem,

$$p_1(x) = \sum_{k1} pa_{k1}^1(x) * p_1(x|pa_{k1}^1(x))$$

$$p_2(x) = \sum_{k2} pa_{k2}^2(x) * p_2(x|pa_{k2}^2(x))$$

Then

$$p'(x) = \sum_{k1} pa_{k1}^1(x) * p_1(x|pa_{k1}^1(x)) * r(src_{R_x} = 1)$$

$$+ \sum_{k2} pa_{k2}^2(x) * p_2(x|pa_{k2}^2(x)) * r(src_{R_x} = 2)$$

where src_{R_x} is the source node of the RV of which the target x is an instantiation and $r(src_{R_x} = i)$ is the reliability of BKB source i contributing to this variable src_{R_x} .

Since $r(src_{R_x} = 1) + r(src_{R_x} = 2) = 1$, then

$p'(x) = p_1(x)r(src_{R_x} = 1) + p_2(x)r(src_{R_x} = 2)$ is also bounded between $[p_1(x), p_2(x)]$.

■

4.2.2 Strong emergence

On the other hand, if the most probable outcomes of “Cross border” for two actors are both “No” but the new emergent outcome becomes “illegally”, then we know a *significant* emergent behavior occurs during the interaction. However, such outcome-switch phenomenon does not always happen when the condition of Definition 1 is satisfied. In the previous example, if the new probability equals 0.37, then the most probable state for “Cross border” in the fused fragment could still be “No”. Therefore, to identify a strong emergent behavior, we provide the second definition as the following.

Definition 2: let x_1, x_2 and x' be the most probable outcomes of the target variable X reasoned from K_1, K_2 and the fused new BKB K' respectively, a strong emergent behavior is identified if $x' \neq x_1$ && $x' \neq x_2$.

Having defined both weak and strong behavior, it is now possible to review the automated algorithm for identifying those emergent behaviors within our model.

4.2.3 Emergence algorithm

The complete algorithm to identify emergent behavior essentially starts first with checking for the most specific case of emergence. If a most probable action for the fused BKB exists that is not the most probable action for either of the fused BKBs, we know we have a case of strong emergence. Failing that, we then check for the existence of weak emergence, by checking all outcomes for the variable of interest. If any value for the fused BKB falls outside the bounds of the individual BKBs, we have found a weak emergence. The algorithm can be summarized as:

Algorithm 1: result = EMERGENT-BEHAVIOR-DETECTION (K_1, K_2, X, e_1, e_2)

1. let $x_1 = \text{MOST-PROBABLE-STATE}(X|K_1, e_1)$
2. let $x_2 = \text{MOST-PROBABLE-STATE}(X|K_2, e_2)$
3. $K' = \text{BKB-FUSION}(K_1, K_2)$
4. let $x' = \text{MOST-PROBABLE-STATE}(X|K', e_1, e_2)$
5. if $x' \neq x_1$ and $x' \neq x_2$
6. result = STRONG_EMERGENT_BEHAVIOR
7. return
8. end
9. for each possible outcome x of variable X in K_1 and K_2
10. let $p_1 = P(X = x|e_1, K_1)$
11. let $p_2 = P(X = x|e_2, K_2)$
12. let $p' = P(X = x|e_1, e_2, K')$
13. if $p_2 \leq p' \leq p_1$ or $p_1 \leq p' \leq p_2$
14. continue;
15. else
16. result = GENERAL_EMERGENT_BEHAVIOR
17. return;
18. end
19. end
20. result = NO_EMERGENT_BEHAVIOR

The intent model provides a mathematically rigorous framework to formulate definition for various types of emergence and design algorithms for detecting emergence, which takes us a great deal closer to being able to understand the conditions under which emergence can happen, and also yield insights into possible scenario outcomes which had not been previously considered. This approach also provides a repeatable process for identifying opportunities for more detailed study of emergent phenomena.

5. EMPIRICAL VALIDATION

As the title of our paper suggests, we have modeled border-crossing behavior during a pandemic. More specifically, we examined the border-crossing behaviors of Mexican citizens during the H1N1 pandemic of 2009. This particular scenario is useful to model because the pandemic provides plentiful examples of external triggers to decision-making, while also ensuring that much macro-level behavior is available for analysis. The scenario is multi-scale, including both national-level events and events local to the Mexican cities of Juarez and Nogales. The national-scale events were explored and discussed in a previous publication⁶, where the focus was more on explanation-driven analysis made possible by the intent model. Cultural influences like age and region were considered, as well as the impetus created by national-level

events, to affect the probable behaviors of demographic actors within the model. The current research explores the effect of including local events, specific to the two border cities Nogales and Juarez, and the effects these two communities could have on one another. We further explore the scenario by combining the micro-scale models through BKB fusion into an intermediate-scale model, for detecting emergent regional behavior that is not exhibited in either of the two local micro-scale models, utilizing the definitions and algorithms that we have formulated for emergence within the intent modeling framework.

5.1 Experimental setting

We built cultural BKB fragments to represent various events and actions taken by national governments and international organizations such as the European Union (EU) and the World Health Organization (WHO). All fragments are built based on public information sources such as demographic reports and news articles. For details about the creation of the BKB fragments, please refer to Santos et al (2011)⁶. In contrast to our previous work⁶, whose main goal was to model the national population, we now focus on modeling changes in local actors' border crossing behaviors and intent. In particular, we model two Mexican cities, Juarez and Nogales, sitting on the border with the US. These two cities were selected for their proximity to the US border and US communities, as well as their relative proximity to each other. The relative proximity would allow their individual behavior to have an effect on each other, leading to novel emergent behaviors. Moreover, we consider middle-aged people from the north as the target group in the simulation, since middle-aged people account for the largest age group, and both Juarez and Nogales are in the northern region, as defined in our previous work⁶.

Our primary interests are the changes in cross-border behavior patterns. Two key factors that may affect people's decisions are considered in the simulation, "people's migration decision" and the "local border control situation", where decisions to migrate to the US highly depend on the local living conditions relative to the nearest US border city. The main differences between Juarez and Nogales lie in their initial border situation and the local tendency to cross the border. In fact, under poor living conditions, even if Juarez people would like to migrate to the US, they are not inclined to cross the border due to panic²⁷, whereas Nogales people have more motivation to risk crossing the border due to indications that the epidemic is worsening even across the border in Arizona^{28,29}. Also, based on the history and experience of Nogales residents, border control is much tighter than in Juarez³⁰⁻³³. Consequently, before the breakout of H1N1, we expect to see that neither Juarez nor Nogales would cross the border individually. To establish the baseline reactions to the H1N1 pandemic, we fuse in national fragments from the previous work⁶ to incorporate the general cultural pieces, such as income information in relation to the tendency to migrate.

In order to study people's reaction to the various events that took place during the pandemic, we fuse in BKB fragments representing events according to the scenario timeline. By assuming that the impact of the events declines with time, we gradually lower the reliability of each event after the breakout. Two types of events are considered in this scenario--national events and regional events. National events refer to events which affect all regions, such as "WHO raises the pandemic level" or "government advises people stay at home", whereas regional events happen locally and thus only influence a specific region. The events we analyzed in the pandemic development with respect to Juarez and Nogales are shown in the scenario time line in Table 1.

Table 1. Description of the experiment results according to national and local events for Juarez and Nogales

TIME	EVENT	SCOPE	INDICATIONS
T1	First case of H1N1 reported in Mexico – business as usual	National	Baseline
T2	First deaths attributed to H1N1 – epidemic outbreak evident	National	Bad health condition triggers the tendency to cross border illegally
T3	WHO sends experts to Mexico to work with health authorities	National	Increased confidence in health response decreases border crossing
T4	EU advises Europeans not to travel to US or Mexico unless the need is urgent WHO elevates the pandemic alert from phase 3 to 4	National	National government policy suppresses the tendency to cross border both legally and illegally
T5	WHO raises the pandemic level from 4 to 5	National	Events enhance the belief that the disease is severe
T6	School closure announced	Juarez	Events enhance the belief that the disease is severe
T7	Pandemic level is high	National	Bad health condition triggers the tendency to cross border illegally
T8	H1N1 conditions worsen in AZ	Nogales	Bad health condition triggers the tendency to cross border both legally and illegally
T9	Mexico shuts down most parts of the country for five days to avoid spread of H1N1, advising citizens to stay in their homes	National	National government policy suppresses the tendency to cross border both legally and illegally
T10	Travels are allowed, and businesses and government have reopened	National	The opportunity to cross illegally is increased
T11	AZ supports two new border fences	Nogales	Crossing border is more difficult
T12	Chihuahua has more H1N1 cases	Juarez	Bad health condition triggers the tendency to cross border legally and illegally
T13	H1N1 deaths reported	Juarez	Bad health condition triggers the tendency to cross border legally and illegally
T14	H1N1 is deadly for children	Nogales	Bad health condition triggers the tendency to cross border
T15	More troops in AZ border	Nogales	Crossing border is more difficult
T16	Border patrol agents are over-defensive	Nogales	Crossing border is more difficult

In the experiment, we first examine how cross-border behaviors of local people are influenced by both national and local events independently, even when some of the events do not have a direct causal link to the variable “(A) Cross border”. Next, we consider the interaction and information exchange between Juarez and Nogales by fusing their individual fragments together (event BKBs are fused from the overall timeline). As new ideas and information could be gained through the interaction, we expect the collective behaviors to be different from the local models.

5.2 Analysis of the results

We performed inferences on the local models of Juarez and Nogales separately, assuming they act independently, and on their fused model. Figure 4 shows the probabilities of the behavior of border-crossings for Juarez and Nogales individually, and the collective behavior after considering their interaction. The results for the individual models (Figure 4(a) and Figure 4(b)) validates our assumption that Juarez is relatively conservative, since results over time indicate that the border-crossing behavior in Juarez is not very sensitive to events. In most cases, the people are reluctant to cross the border, although local border control is relatively light. In contrast, in Nogales, the border-crossing behavior is more aggressive and sensitive to events. People in Nogales are more likely to cross the border whenever living conditions worsen. However, their movements are restricted by the stricter border control. We can observe from the results that compared with legal border-crossings, illegal border-crossings are more sensitive to events. Its likelihood increases when

health conditions worsen, and decreases when the government interrupts. This might be explained by the fact that health conditions have a more significant impact on low-income citizens, who are less likely to have the opportunity to migrate legally. The results for the time steps with major events are provided for Juarez and Nogales in Table 1. Results from their fused model (Figure 4(c)) demonstrate an unexpected change in their collective behavior after interaction. Specifically, although neither region selects crossing the border legally or illegally over not crossing the border across all time steps, by fusing their knowledge, it becomes more likely to cross the border illegally than not at T15 and T16. According to definition 2, this is a STRONG emergent behavior, since the most probable outcome in the fused model has switched from “no” to “illegal”, and neither Juarez nor Nogales have taken such a decision based on their local models. It may be explained by the fact that the panic in Nogales spreads into Juarez and increases Juarez people’s tendency to cross the border; equally, Nogales residents find it possible to cross the border at Juarez.

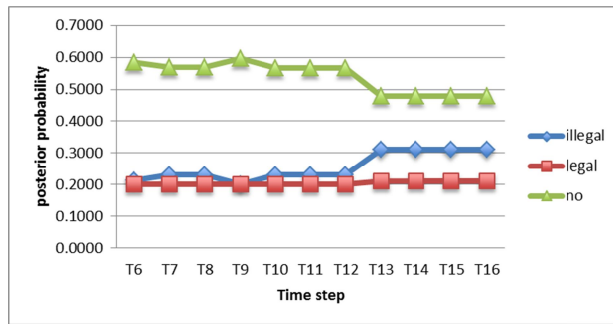

(a)

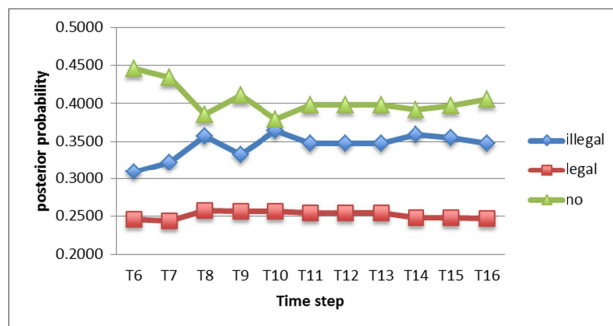

(b)

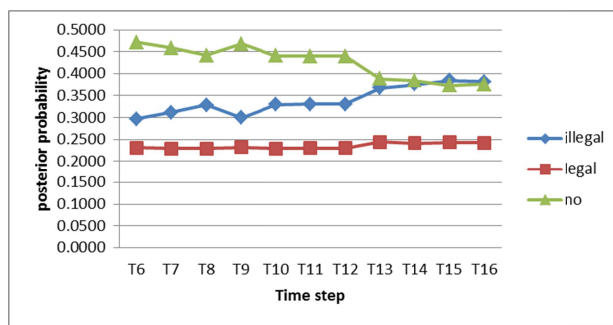

(c)

Figure 4. Probability of crossing-border illegally, legally and not crossing-border from time step 6 to 18 for (a) Juarez regional model, (b) Nogales regional model, (c) fused model of Juarez and Nogales

In Figure 5, we compare the behavior of illegal border crossings of the three models together. The probability of illegal border-crossings in Juarez increases over time because of the threatening health conditions, while the probability of

illegal border-crossings in Nogales increases in the middle because of health conditions, but subsequently decreases in the end because of strict border control. Their fused border-crossing behaviors exceed the range of their individual behaviors from T12 because both regions find a motivation and an opportunity to cross the border after interacting and communicating with each other. In particular, Nogales is searching for a border with lax security control that Juarez can provide, and Nogales spreads their panic to Juarez, which also motivates Juarez people to cross the border. In fact, the emergent behavior is identified from T12 as the intention of illegally crossing in the fused model becomes greater than both Juarez and Nogales individually, corresponding to a weak emergent behavior as identified in Definition 1. Moreover, the probability difference between the fused model and the other two grows, which finally triggers the strong emergent behaviors in T15 and T16.

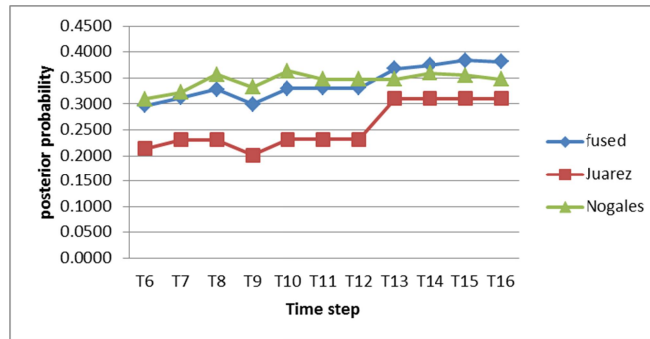

Figure 5. Probability of crossing-border illegally for the regional models of Juarez and Nogales individually and the fused model

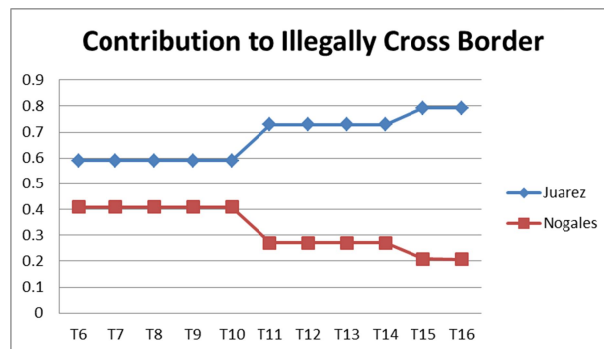

Figure 6. Contribution analysis of Juarez and Nogales

To analyze which region is selected by people to illegally cross the border, we measured the contribution of the nodes “source_LBC=Juarez” and “source_LBC=Nogales” (source nodes to “(B) Local border control”) to the node “Cross-border = illegal”. The result is plotted in Figure 6. We observe that the contribution of Juarez is continuously higher than Nogales because Juarez’ border control is more lax. The contribution of Juarez increases as time goes by because the border control of Nogales becomes stricter over time. As a result, more people select to cross the border through Juarez.

From this analysis, we can see that by fusing local, micro-scale models, we can not only obtain an intermediate-scale model of the region represented by adjacent locales, we gain insight into possible behaviors that could emerge through the interactions of actors from each of the locales. This interaction is represented within the intent model by the generation of new BKB inferences that changes the posterior probabilities for various decision variables. Through this validation experiment, we have demonstrated how emergent social behavior can be captured within the intent framework and how this can be procedurally identified.

6. CONCLUSION

Emergent behaviors in social systems are being studied by researchers because they need to be captured for accurate modeling of complex and dynamic social phenomena. Through understanding the dynamism between individuals and

groups, we seek to provide additional insights useful for planning for and recovering from natural disasters and other catastrophic events. In this paper, we proposed a methodology to identify emergent behaviors through a framework based on probabilistic knowledge representations. Our computational framework was validated through modeling and simulating human behaviors occurring near a national border during the 2009 H1N1 pandemic in Mexico. Based on an intent-driven modeling approach, we presented a multi-scale model including both national and local level events. Emergent behavior was identified during the pandemic by integrating individual models, and explained by analyzing multiple contributing factors relevant to individuals residing in two border regions (Juarez and Nogales) during the pandemic. Individual behaviors were inferred through BKB reasoning, and the probability contributions were considered for identifying emergent behaviors.

We made certain assumptions for representing human behaviors through computational representation. Even though temporal aspects were incorporated through the use of event timelines, some individual time constraints were not considered in this study. This issue will be more rigorously addressed by employing temporal BKBs in our future research. In addition, we will introduce other mathematical structures, such as social networks to represent additional social relationships within and between groups. This will also help in conducting sophisticated what-if analysis.

REFERENCES

- [1] Magee, C. L. and de Weck, O., "Complex System Classification," Fourteenth Annual International Symposium of the International Council On Systems Engineering, (2004).
- [2] Miller, J. H. and Page, S. E., [Complex Adaptive Systems: An Introduction to Computational Models of Social Life], Princeton University Press, (2007).
- [3] Sawyer, R. K., [Social Emergence: Societies As Complex Systems], Cambridge University Press, New York, 276 (2005).
- [4] Provitolo, D., Paillard, E., and Muller, J., "Emergent Human Behavior During a Disaster: Thematic versus Complex Systems Approach," Proc. of EPNACS within ECCS'11: Emergent Properties in Natural and Artificial Complex Systems, Vienna, Austria, 47-57(2011).
- [5] Santos Jr., E., and Zhao, Q., "Adversarial Models for Opponent Intent Inferencing," in Adversarial Reasoning: Computational Approaches to Reading the Opponents Mind, Chapman & Hall/CRC, Boca Raton, 1–22(2006).
- [6] Santos, E. E., Santos Jr., E., Korah, J., Thompson, J. E., Kim, K., George, R., Gu, Q., Jurmain, J., Subramanian, S., and Wilkinson, J.T., "Intent-Driven Behavioral Modeling during Cross-Border Epidemics," Proc. 2011 IEEE International Conference on Privacy, Security, Risk and Trust and IEEE International Conference on Social Computing, 748–755 (2011).
- [7] Aristotle and Ross, W. D., [Metaphysics], Digireads.com Publishing, Stilwell, KS, USA (2006).
- [8] Caws, P., "Science, Computers, and the Complexity of Nature," *Philosophy of Science* 30(2), 158–164 (1963).
- [9] Simon, H. A., "The Architecture of Complexity," *Proc. of the American Philosophical Society*, 106(6), 467–482 (1962).
- [10] Hayek, F. A., "The theory of complex phenomena," in *Critical approaches to science and philosophy*, Bunge, M., Ed., Collier-Macmillan, 332–349 (1964).
- [11] Wimsatt, W. C., "Complexity and Organization," *PSA: Proc. of the Biennial Meeting of the Philosophy of Science Association* 1972, 67–86 (1972).
- [12] Hexmoor, H., Lammens, J., Caicedo, G., Shapiro, S. C., and Hall, B., "Behavior Based AI , Cognitive Processes , and Emergent Behaviors in Autonomous Agents," in *Applications of Artificial Intelligence in Engineering VIII, Vol. 2 Applications and Techniques*, Rzevski, G., Pastor, J. and Adey, R., Eds., Elsevier, 447–461(1993).
- [13] Mataric, M. J., "Designing Emergent Behaviors: From Local Interactions to Collective Intelligence," *Proceedings of the second international conference on From animals to animats 2 : simulation of adaptive behavior*, 432–441 (1993).
- [14] Bar-yam, Y., "A Mathematical Theory of Strong Emergence Using Multiscale Variety," *Complexity* 9(6), 15–24 (2004).
- [15] Casper, N., "Organizational Leadership's impact on Emergent Behavior during Disaster Response and Recovery Operations," Naval Postgraduate School, (2011).
- [16] Santos, E. E., Santos Jr., E., Wilkinson, J. T., Korah, J., Kim, K., Li, D., and Yu, F., "Modeling Complex Social Scenarios Using Culturally Infused Social Networks," *Proc. 2011 IEEE International Conference on Systems, Man, and Cybernetics*, 3009 – 3016(2011).

- [17] Santos Jr., E., McQueary, B., and Krause, L., “Modeling Adversarial Intent for Interactive Simulation and Gaming: The Fused Intent System,” in Proc. SPIE 6965, 696503(2008).
- [18] Santos Jr., E., and Santos, E. S., “A Framework for Building Knowledge-Bases Under Uncertainty,” *Journal of Experimental and Theoretical Artificial Intelligence* 11(2), 265–286 (1999).
- [19] Santos, E. E., Santos Jr., E., Wilkinson, J. T., and Xia, H., “On a framework for the prediction and explanation of changing opinions,” in Proc. 2009 IEEE international conference on Systems, Man and Cybernetics, 1446–1452 (2009).
- [20] Santos, E. E., Santos Jr., E., Pan, L., and Wilkinson, J. T., “Culturally Infused Social Network Analysis,” in Proc. International Conference on Artificial Intelligence (IC-AI), 449–455 (2008).
- [21] Santos Jr., E., and Negri, A., “Constructing adversarial models for threat/enemy intent prediction and inferencing,” in Proc. SPIE 5423, 77–88 (2004).
- [22] Rosen, T., Shimony, S. E., and Santos Jr., E., “Reasoning with BKBs – Algorithms and Complexity,” *Annals of Mathematics and Artificial Intelligence* 40(3-4), 403–425 (2004).
- [23] Pioch, N. J., Melhuish, J., Seidel, A., Santos Jr., E., Li, D., and Gorniak, M., “Adversarial intent modeling using embedded simulation and temporal Bayesian knowledge bases,” in Proc. SPIE 7348, 73480E(2009).
- [24] Santos Jr., E., Zhao, Q., Pratto, F., Pearson, A. R., McQueary, B., Breeden, A., and Krause, L., “Modeling multiple communities of interest for interactive simulation and gaming: the dynamic adversarial gaming algorithm project,” in Proc. SPIE 6564, 656410 (2007).
- [25] Santos, E. E., Santos, Jr., E., Pan, L., Wilkinson, J. T., Thompson, J. E., and Korah, J., “Infusing Social Networks with Culture,” *IEEE Transactions on Systems, Man and Cybernetics: Systems PP(99)*, 1-17(2013) [doi:10.1109/TSMC.2013.2238922].
- [26] Santos Jr., E., Wilkinson, J. T., and Santos, E. E., “Bayesian Knowledge Fusion,” in Proc. 22nd International FLAIRS Conference, 559–564 (2009).
- [27] Pacheco, J., “System keeps outbreaks from causing panic,” *ABQ JOURNAL* May(11) (2009).
- [28] Bowers, T., and The Arizona Republic, “All 4 Arizona flu cases are children; three Phoenix schools closed,” *Tucson Citizen*, 2009, <<http://tucsoncitizen.com/morgue/2009/04/30/115542-all-4-arizona-flu-cases-are-children-three-phoenix-schools-closed/>> (8 March 2013).
- [29] Associated Press, “Girl is fourth Arizonan to die of swine flu,” *AZ Central*, 2009, <http://www.azcentral.com/news/articles/2009/05/27/20090527swineflu-az27-ON.html?nclick_check=1> (18 February 2013).
- [30] Thomson Reuters, “U.S. Starts Work on Virtual Border Fence in Arizona,” 2009, <<http://www.newsmax.com/US/virtual-border-fence/2009/05/13/id/330065>> (18 February 2013).
- [31] U.S. Immigration and Customs Enforcement, “Fact Sheet: ICE Shadow Wolves,” 2007, <<http://www.ice.gov/news/library/factsheets/shadow-wolves.htm>> (18 February 2013).
- [32] Wagner, D., “National Guard to arrive at Arizona-Mexico border - USATODAY.com,” in *USA Today* (2010).
- [33] Archibold, R. C., “Border Patrol Agent’s Trial in Killing of Illegal Immigrant Starts in Arizona - New York Times,” in *The New York Times*, New York, NY, USA (2008).